

DOT/FAA/CT-94/74

FAA Technical Center
Atlantic City International Airport,
N.J. 08405

Aircraft Fuel System Lightning Protection Design and Qualification Test Procedures Development

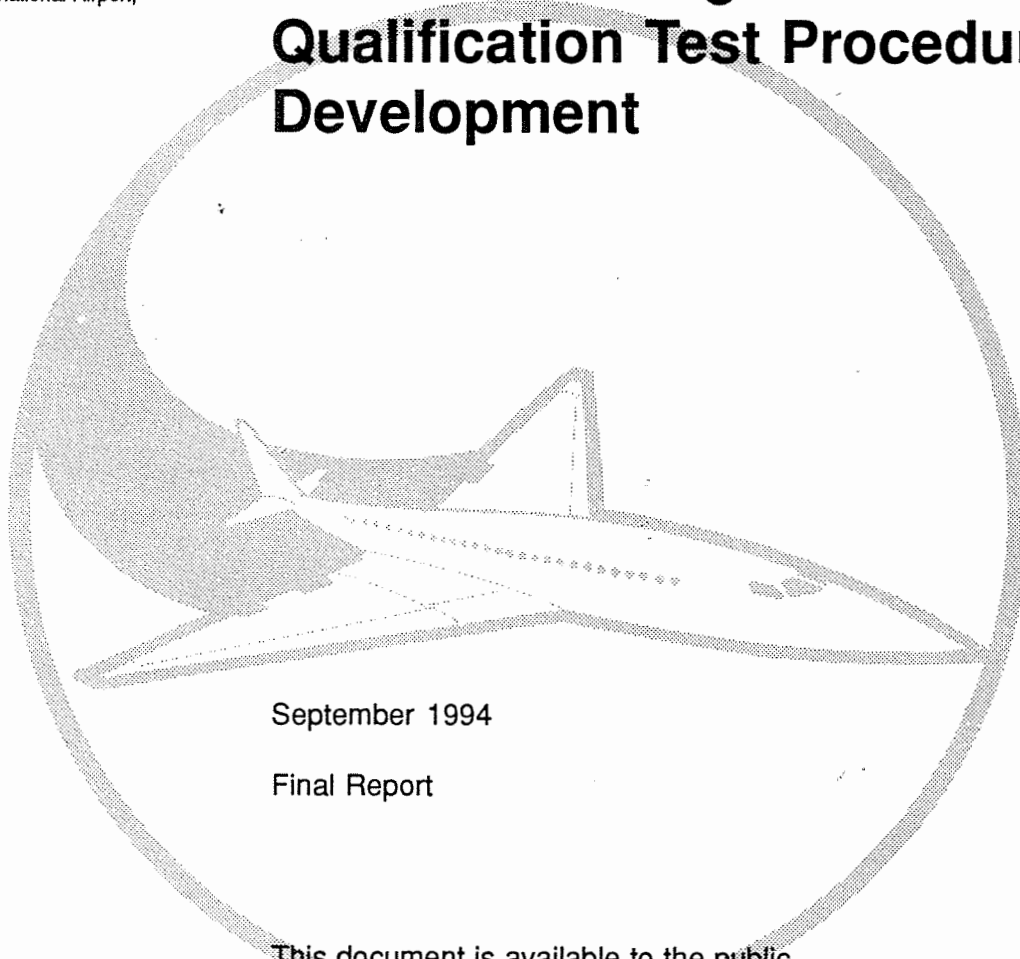

September 1994

Final Report

This document is available to the public
through the National Technical Information
Service, Springfield, Virginia 22161.



U.S. Department of Transportation
Federal Aviation Administration

NOTICE

This document is disseminated under the sponsorship of the U. S. Department of Transportation in the interest of information exchange. The United States Government assumes no liability for the contents or use thereof.

The United States Government does not endorse products or manufacturers. Trade or manufacturers' names appear herein solely because they are considered essential to the objective of this report.

1. Report No. DOT/FAA/CT-94/74		2. Government Accession No.		3. Recipient's Catalog No.	
4. Title and Subtitle Aircraft Fuel System Lightning Protection Design and Qualification Test Procedures Development				5. Report Date September 1994	
				6. Performing Organization Code	
7. Author(s) Keith E. Crouch				8. Performing Organization Report No. LT-94-1067	
9. Performing Organization Name and Address Lightning Technologies, Inc. 10 Downing Parkway Pittsfield, MA 01201				10. Work Unit No. (TRAIS) DTFA03-92-C-00003	
				11. Contract or Grant No.	
12. Sponsoring Agency Name and Address US Department of Transportation Federal Aviation Administration Technical Center Atlantic City International Airport, NJ 08405				13. Type of Report and Period Covered Final Report	
				14. Sponsoring Agency Code ACD-230	
15. Supplementary Notes FAA Program Manager: Michael S. Glynn					
16. Abstract <p>The Navy and the Air Force recognized the need for improved test procedures for evaluating the lightning protection design of aircraft fuel systems. Under their sponsorship, a program to develop adjustable, standard ignition sources which could be used to calibrate techniques for detecting ignition sources during lightning testing was established. The minimum ignition levels of voltage sparks and hot spots were established under the program before it was terminated due to funding problems.</p> <p>The present program, under FAA sponsorship, is a continuation of the original program. The Standard Voltage Spark Ignition Source and the Standard Hot Spot Ignition Source were completed and documented. The most promising approach for developing a Standard Thermal Spark Ignition Source was determined and is presented.</p> <p>Photographic detection techniques were investigated and the limitations determined. The presence of light on a photographic film indicated the possibility of an ignition source but can not confirm the ignition probability (if any).</p> <p>Hydrogen mixtures appear to provide the ability to have adjustable ignition probabilities and low energy (low over-pressure) ignitions.</p>					
17. Key Words Lightning Fuels Testing Qualification Design Fuel Tanks			18. Distribution Statement Document is available to the public through the National Technical Information Service Springfield, VA 22161		
19. Security Classif. (of this report) Unclassified		20. Security Classif. (of this page) Unclassified		21. No. of Pages 187	22. Price

TABLE OF CONTENTS

	PAGE
EXECUTIVE SUMMARY	ix
INTRODUCTION	1
NAVAL AIR DEVELOPMENT CENTER PROGRAM	2
State-of-the-Art Review	2
Photographic Detection Technique	2
Propane/Air Detection Technique	2
Pass/Fail Criteria	2
Minimum Ignition Thresholds	3
Voltage Sparks	3
Hot Spots	6
Corona	6
Thermal Sparks	6
Development of Improved Test Procedures and Detection Techniques	6
Flow Filling Procedures	9
Standard Voltage Spark Ignition Source	9
Thermal Spark Source	9
INTERIM DEVELOPMENTS	9
Voltage Spark Source	10
FAA PROGRAM	12
Development Test Plan	15

TABLE OF CONTENTS

	PAGE
Develop and Package a Thermal Spark Source	15
Hot Particles	15
Graphite/Wire Contact	16
External Sources	17
Wire/Carbon Contact	17
Standard Voltage Spark Ignition Source	23
Standard Hot Spot Ignition Source	24
Ignition Detection Technique Development	24
Photographic Ignition Detection Technique (PIDT)	25
Combustible Vapor Ignition Detection Technique (CVIDT)	25
Sensitive Fuels	26
Demonstration Test Plan	30
Demonstration Tests	30
Summary	31
Materials Evaluation (Hot Spots)	31
Fuel Probe (Voltage Spark)	31
Fuel Line Couplings (Thermal Spark)	31
Fasteners (Thermal Spark)	34
Industry Review	34
Proposed Test Standard	34

TABLE OF CONTENTS

	PAGE
CONCLUSIONS AND RECOMMENDATIONS	34
Thermal Sparks	34
Photographic Detection Technique	35
Combustible Vapor Ignition Detection Technique	35
APPENDICES	
A - Standard Thermal Spark Ignition Source	
B - Standard Voltage Spark Ignition Source	
C - Standard Hot Spot Ignition Source	
D - Photographic Ignition Detection Techniques	
E - Combustible Vapor Ignition Detection Techniques	
F - Proposed Test Standard	

LIST OF FIGURES

FIGURE		PAGE
1	NADC-86100-20, Figure 12, Probability of Ignition vs. Spark Energy	5
2	NADC-86100-20, Figure 23, Probability of Ignition vs. Spark Energy	7
3	Ignition Energy vs. Gap Spacing	10
4	Photographs of Non-incendiary Thermal Sparks	11
5	Ignition Probability Plots of NADC Data and Interim Data, Ignition Probability vs. Voltage Spark Energy	14
6	Typical Rotating Electrode Tests	18
7	Typical Rotating Electrode Tests	19
8	Exploding Wire Particles Entering the Chamber	20
9	Second Crossed Wire Fixture and Thermal Spark Shower	21
10	From Lewis and Von Elbe	27
11	Ignition Probability Plot of H ₂ -O ₂ -Ar Data, (7% H ₂ , 21% O ₂ , 72% Ar)	28
12	From Oh & Schneider	32
13	From Oh & Schneider	33

LIST OF TABLES

TABLE		PAGE
1	Spark Ignition Data	4
2	Hot Spot Ignition Data	8
3	Comparison of Ignition Probability vs. Voltage Spark Energy for Original NADC Tests and Later Tests	13
4	Comparison of Ignition Probabilities Taken from Replots of NADC and Interim Data	15
5	Ignition Probability of Hydrogen (7%), Oxygen (21%) and Argon (72%) as a Function of Voltage Spark Energy	29
6	Ignition Probabilities Taken from Plot (Figure 11)	29

EXECUTIVE SUMMARY

The need for improved test procedures to evaluate the lightning protection design of aircraft fuel systems has long been recognized. Initial efforts were carried out by Lightning Technologies, Inc. and Lightning Transients Research Institute under funding provided by the Naval Air Development Center and the Air Force Wright Aeronautical Laboratories.

During the first phase of that effort, a state-of-the-art review concluded that the procedures and techniques were adequate but that the criterion was lacking. A plan for investigating basic ignition processes and developing an acceptable criterion was developed. The plan provided for the development of adjustable, standardized ignition sources which could be used to calibrate various ignition detection techniques. The plan also called for the development of ignition detection techniques which would determine the potential of a lightning test related ignition source to ignite a fuel/air mixture.

During the second phase of that effort, minimum ignition levels for voltage sparks, corona, hot spots, and thermal sparks were investigated. Voltage spark ignitions at the 200 μ J level were found to be quite rare, between 0.01 and 0.1% occurrence rate. Hot spots ignited all mixtures at levels of 900°C and corona was determined to be incapable of causing an ignition. Thermal spark ignition levels were not determined.

Funding problems prevented the completion of the initial program. In the time between loss of Navy and Air Force funding and the beginning of FAA funding, improvements were made to the Standard Voltage Spark Ignition Source and tests with the new source were made.

Under FAA sponsorship, the Standard Voltage Spark Ignition Source and the Standard Hot Spot Ignition Source were developed and packaged. Several thermal spark ignition sources were investigated and the most promising approach is presented.

The ability of photography to characterize ignition sources was investigated and its limitations was determined. It was found that the presence of light on a film, subject to interpretation by a person trained in reading the films, gives an indication of the possibility of ignition but is not able to confirm the probability level of that ignition. A spot of light on a film could indicate an ignition source if the spot was caused by voltage spark but not if the spot was caused by a hot spot.

Detection of ignition sources using hydrogen gas mixtures appears to allow for the adjustment of the ignition probability and as well as provide a burn with low energy release. Over-pressures with hydrogen mixtures appeared to be so low as to almost not burst the blow-out panels in the test chamber.

INTRODUCTION

The need for improved test procedures to evaluate the protection design of aircraft fuel systems has long been recognized. Most of the work reported here is the result of discussions held at the 8th International Aerospace and Ground Conference on Lightning and Static Electricity, held at Ft. Worth Texas in June 1983. The Naval Air Development Center (NADC) supported by the Air Force Wright Aeronautical Laboratories contracted with Lightning Technologies, Inc. (LTI) to develop, document and verify an improved set of test procedures. Lightning and Transients Research Institute (LTRI) was a subcontractor to LTI.

In 1992, the Federal Aviation Administration (FAA) Technical Center continued sponsorship of the program. The objective continued to be development of procedures which could be used to guide both design and qualification tests on new aircraft fuel systems. The procedures are to include a means for determining if the design under test meets, exceeds or fails the design criteria and the margin by which the design exceeds, or fails that criteria. The procedures are to be applicable to conventional, advanced composite, or any new technology design.

The Navy program was divided into five phases:

- Phase I - State-of-the-Art Review
- Phase II - Determination of Minimum Fuel (Vapor) Ignition Thresholds
- Phase III - Development of Improved Test Procedures and Criteria
- Phase IV - Evaluation and Demonstration of the Proposed Procedures and Criteria
- Phase V - Publication of Improved Test Procedures and Criteria

Phase I and portions of phases II and III were completed under NADC sponsorship. Work on phases II, III, IV, and V continued under FAA support. The initial effort was divided between Lightning Technologies, Inc. (LTI) and Lightning Transients Research Institute (LTRI) until 1986 when LTRI ceased operations. LTI conducted the program after that time.

This report provides a review and summary of all work completed under both the NADC and FAA programs. More complete descriptions of the work accomplished are given in various reports issued during the programs. Those reports are referenced in the text for readers who wish further details.

NAVAL AIR DEVELOPMENT CENTER PROGRAM

STATE-OF-THE-ART REVIEW.

A review of the existing fuel system lightning test practice was conducted and reported in 1985 (Ref. 1). That review found that the threat definition and testing practices in use were adequate and were dictated by the detection techniques used for the tests. Approximately 75% of all testing used(s) the photographic detection technique. Other tests were conducted with propane/air mixtures used to detect ignition sources. The techniques and procedures followed were contained in References 2 and 3.

PHOTOGRAPHIC DETECTION TECHNIQUE. The photographic technique was found to have little theoretical basis and no correlation to the ignition of fuel vapors. Light from non-incendiary sources can not be distinguished from ignition sources. Light from 0.2 mJ sparks may not be detectable on f/4.7-3000 ASA polaroid photographs. Translucent structural materials conduct background light sufficient to cover all but the most vigorous spark sources.

PROPANE/AIR DETECTION TECHNIQUE. Propane vapors do not always ignite under what appears to be identical conditions and photographs often reveal significant spark activity without ignition.

Neither technique could be quantified so as to determine the pass/fail margin.

PASS/FAIL CRITERIA. A defined pass/fail criteria was not found. All of the test procedures documents indicated that the pass/fail criteria was not part of that documents' contents and was to be established by the applicant in consultation with the regulatory authority. However, the detection techniques both included statements which implied that they were based on the 0.2 mJ spark "ignition threshold" and would detect ignition sources exceeding that level.

-
- Ref. 1 Crouch, K.E. and Robb, J.D., *Aircraft Fuel System Lightning Protection Design and Qualification Test Procedures Development*, NADC Report No. NADC-85090-20, February 1985.
- Ref. 2 SAE Committee AE4L Report, *Lightning Test Waveforms and Techniques for Aerospace Vehicles and Hardware*, June 1978.
- Ref. 3 MIL-STD-1757A, *Lightning Qualification Test Techniques for Aerospace Vehicles and Hardware*, dated 20 July 1983.

A review of the literature indicated that the potential ignition sources were:

- Voltage Sparks - The electrical breakdown of the fuel/air mixture between two separated conductors.
- Hot Spots - The heating of a structural surface in contact with fuel/air vapors by lightning currents to a temperature which would ignite the mixture.
- Corona - An electrical glow discharge from a point source into a fuel/air mixture.
- Thermal Sparks (Spark Showers) - Particles emitted by melting and vaporization of conductive materials in point contact.

Ignition of fuel/air mixtures by voltage sparks had received considerable study and many papers on the subject by authors such as Lewis and Von Elbe, and Barretto were reviewed. The 0.2 mJ ignition threshold was a product of this work. However, the intent of the studies was to establish the lowest ignition limit and not to establish a test criteria. The literature does not address the probability of ignition of the 0.2 mJ voltage spark.

Very little work was found relating to the ignition thresholds for hot spots, corona, or thermal sparks. The literature reviewed was either incomplete or did not relate to the ignition problem in fuel systems.

MINIMUM IGNITION THRESHOLDS.

The objective of this part of the program was to establish the minimum ignition thresholds for all the potential ignition sources. The work accomplished was reported in 1986 (Ref. 4).

Voltage Sparks. A voltage spark source, patterned after the work of Lewis and Von Elbe, was constructed and tests were conducted on different stoichiometric mixtures of propane, pentane, and JP-4 in 20% and 30% oxygen content air. Table 1 gives voltage spark ignition data for the mixtures. This data indicated that the 0.2 mJ spark ignition probability is on the order of 1 in 1000 to 1 in 10,000.

Some problems with the results are discussed in the report. Much of the data appears normal, as shown in Figure 1, where the data shows a progression from lower

Ref. 4 Crouch, K.E., *Aircraft Fuel System Lightning Protection Design and Qualification Test Procedures Development: Investigation of Fuel Ignition Sources*, NADC Report No. NADC-86100-20, August 1986.

TABLE 1. SPARK IGNITION DATA

The spark energy level (μJ) corresponding to selected ignition probabilities (0.01 to 50%) is summarized for five fuel/air mixtures at different concentrations.

Fuel Mixture ¹	0.01% ² (μJ)	0.1% ² (μJ)	1% ² (μJ)	10% ² (μJ)	50% ² (μJ)
Propane - 20% Oxygen					
1.0	520	585	675	810	1020
1.1	515	565	625	725	865
1.2	440	485	550	645	710
1.3	335	385	450	560	730
1.4	440	515	625	810	1110
Pentane - 20% Oxygen					
1.3	185	230	295	420	645
1.4	320	370	430	530	690
1.5	170	210	270	390	610
1.6	275	335	425	595	885
Propane - 30% Oxygen					
1.0	70	80	100	130	185
1.1	45	55	70	100	155
1.2	40	50	70	100	160
1.3	50	60	80	110	165
1.4	65	85	105	150	230
Pentane - 30% Oxygen					
1.3	50	60	70	95	130
1.4	35	55	70	100	145
1.5	45	55	70	100	150
1.6	75	85	100	125	165
JP-4 - 20% Oxygen					
2.5 ³	895	1000	1140	1360	1700
3.0	630	705	805	965	1210
3.5	715	725	910	1090	1360

¹ Stoichiometric

² Probabilities of ignition

³ Percent Volume

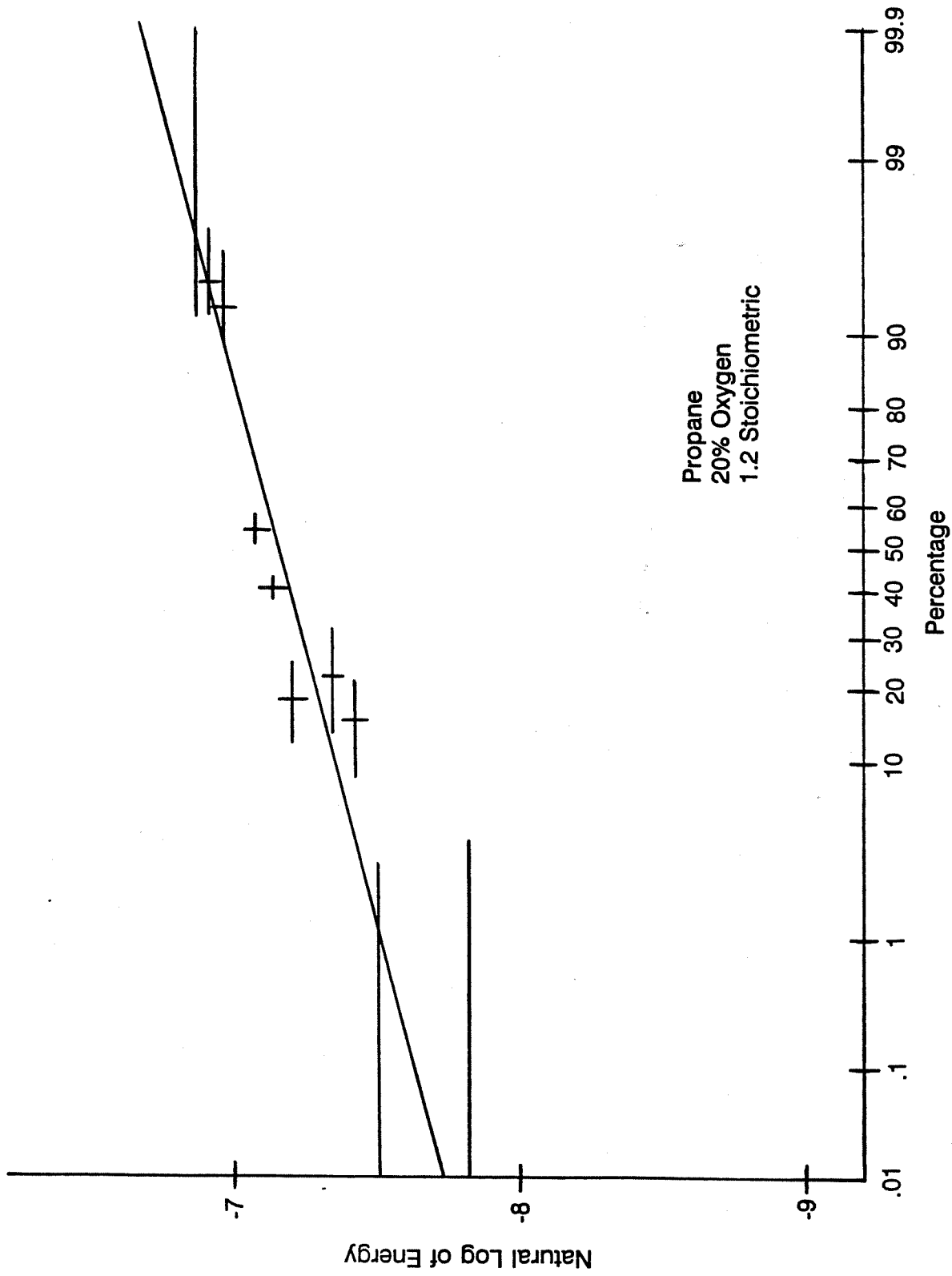

FIGURE 1. NADC-86100-20, FIGURE 12, PROBABILITY OF IGNITION VS. SPARK ENERGY

to higher spark energies. However, some plots, as shown in Figure 2, show no relationship between the spark energy and the ignition probability. No explanation was found.

HOT SPOTS. Following the example of Dimetre and White, a stainless steel foil was electrically heated in a fuel/air mixture. The foil, approximately 1 cm² (both sides exposed to the mixture), was heated for about 1 second. As shown in Table 2, all mixtures ignited at 900°C. The temperature control/measurement system was not capable of setting/detecting temperature levels closer than $\pm 50^\circ\text{C}$. No probability of ignition versus temperature could be detected.

CORONA. As predicted by Barretto, corona (glow discharges) was found incapable of igniting fuel/air mixtures.

THERMAL SPARKS. Attempts at generating controlled thermal sparks were unsuccessful. An attempt was made to create a thermal spark shower by crossing smooth, round aluminum wires. It appeared that, even under very light pressure, microscopic imperfections in the surfaces caused significant variations in the resulting particle emission.

Exploding fine wires were also considered, but no tests were conducted.

DEVELOPMENT OF IMPROVED TEST PROCEDURES AND DETECTION TECHNIQUES.

The development of an ignition detection technique with the ability to determine margin implies the ability to provide a controlled, repeatable ignition source signal which can be used to verify the detection technique. Once a means of generating an ignition source was developed, it must be packaged so that it could be used by industry laboratories.

The initial work on ignition was done using partial pressure techniques to introduce vapor mixtures into the test volume. Very few fuel system structures can withstand vacuum pressures, so other methods of introducing the mixture into the volume were needed.

Initial work in the area of developing laboratory ignition sources was reported at the conclusion of the NADC work (Ref. 5).

Ref. 5 Crouch, K.E., *Aircraft Fuel System Lightning Protection Design and Qualification Test Procedures Development: Development of Standard Ignition Sources*, Lightning Technologies, Inc. Report No. LT-89-583, dated December 1989.

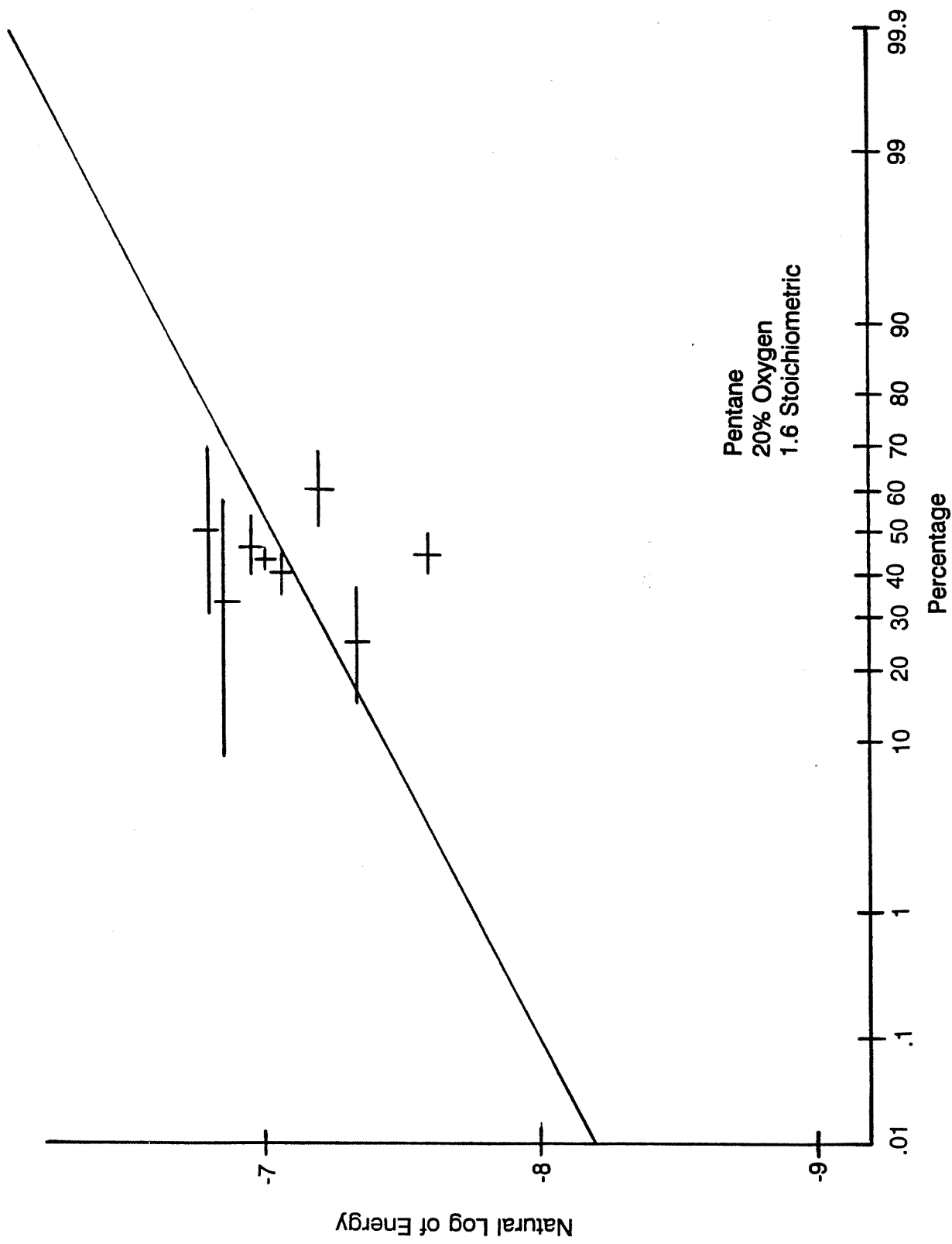

FIGURE 2. NADC-86100-20, FIGURE 23, PROBABILITY OF IGNITION VS. SPARK ENERGY

TABLE 2. HOT SPOT IGNITION DATA

The hot spot temperature (°C) required to ignite five fuel/air mixtures at different concentrations is given for each of the ten tests conducted.

Fuel Mixture ¹	Test Nos.									
	1	2	3	4	5	6	7	8	9	10
	Temperature °C									
	20% Oxygen - Propane Fuel									
1.1	900	900	900	900	900	900	900	900	900	900
1.2	900	900	900	900	900	900	900	900	900	900
1.3	900	900	900	900	900	900	900	900	900	900
	30% Oxygen - Propane Fuel									
1.1	900	900	900	900	900	900	900	900	900	900
1.2	900	900	900	900	900	900	900	900	900	900
1.3	900	900	900	900	900	900	900	900	900	900
	20% Oxygen - Pentane Fuel									
1.3	900	900	900	900	900	900	900	900	900	900
1.4	900	900	900	900	900	900	900	900	900	900
1.5	900	900	900	900	900	900	900	900	900	900
	30% Oxygen - Pentane Fuel									
1.3	900	900	900	900	900	900	900	900	900	900
1.4	900	900	900	900	900	900	900	900	900	900
1.5	900	900	900	900	900	900	900	900	900	900
	20% Oxygen - JP-4 Fuel									
2.5 ²	900	900	900	900	900	900	900	900	900	900
3.0	900	900	900	900	900	900	900	900	900	900
3.0	900	900	900	900	900	900	900	900	900	900

¹ Stoichiometric

² Percent Volume

FLOW FILLING PROCEDURES. Methods of calculating, measuring, and verifying the flow of fuel vapors and gases (oxygen, nitrogen, etc.) were developed and tested. Rotameter type flowmeters were calibrated using a displacement fixture and used to control the mixtures introduced into the test volume.

Tests of ignition levels in the flow filled volumes were compared to vacuum chamber data to show equivalence.

STANDARD VOLTAGE SPARK IGNITION SOURCE. Initial concepts for developing a standard voltage spark ignition source (SVSIS) were explored. During the initial testing it was found that the 2 mm gap sparked at 7.95 ± 0.5 kV in air. When immersed in fuel vapors, at 8 kV the time delay to spark over was up to several seconds. Generally, it is not possible to hold exact voltages for that period of time and the voltage will move upward with time. Consequently, the actual sparking voltage ranged from 8 to 11 kV. To alleviate this problem, a corona source was added to the spark fixture to stabilize breakdown. It was later found that Lewis and Von Elbe added a radio active source to their equipment to stabilize their breakdown voltages.

Tests were conducted which verified that the corona source did not affect the ignition probabilities of the fuel/air mixtures.

The original SVSIS used fixed ceramic capacitors. At levels of several kV, the capacitance is voltage dependent. The errors introduced by this problem were not evaluated.

THERMAL SPARK SOURCE. As part of the investigations into the behavior of thermal spark sources, tests on small gap voltage spark sources was carried out. The premise was that most thermal spark processes will result or conclude in a conduction of current across a very small gap, in addition to ejecting particles out into the vapor. These tests were conducted to see how much energy must be deposited in the small gap to cause an ignition.

The results are shown in Figure 3. At spacings of 50 microns (0.002 in.) or less, which would be representative of thermal spark gaps, the ignition energy rises to very large values (joules). Figure 4 shows the light emitted by non-incendiary sparks in these gaps.

INTERIM DEVELOPMENTS

Between the time that the NADC program activities ceased and the FAA program started, some additional efforts were carried out to improve the equipment while it was used for various customer tests (Ref. 6).

Ref. 6 Plumer, J.A., *B-2 Fuel Tank Skin Lightning Tests with JP-8 Fuel Vapor*, Lightning Technologies, Inc. Report No. LT-92-764 (Unpublished Data).

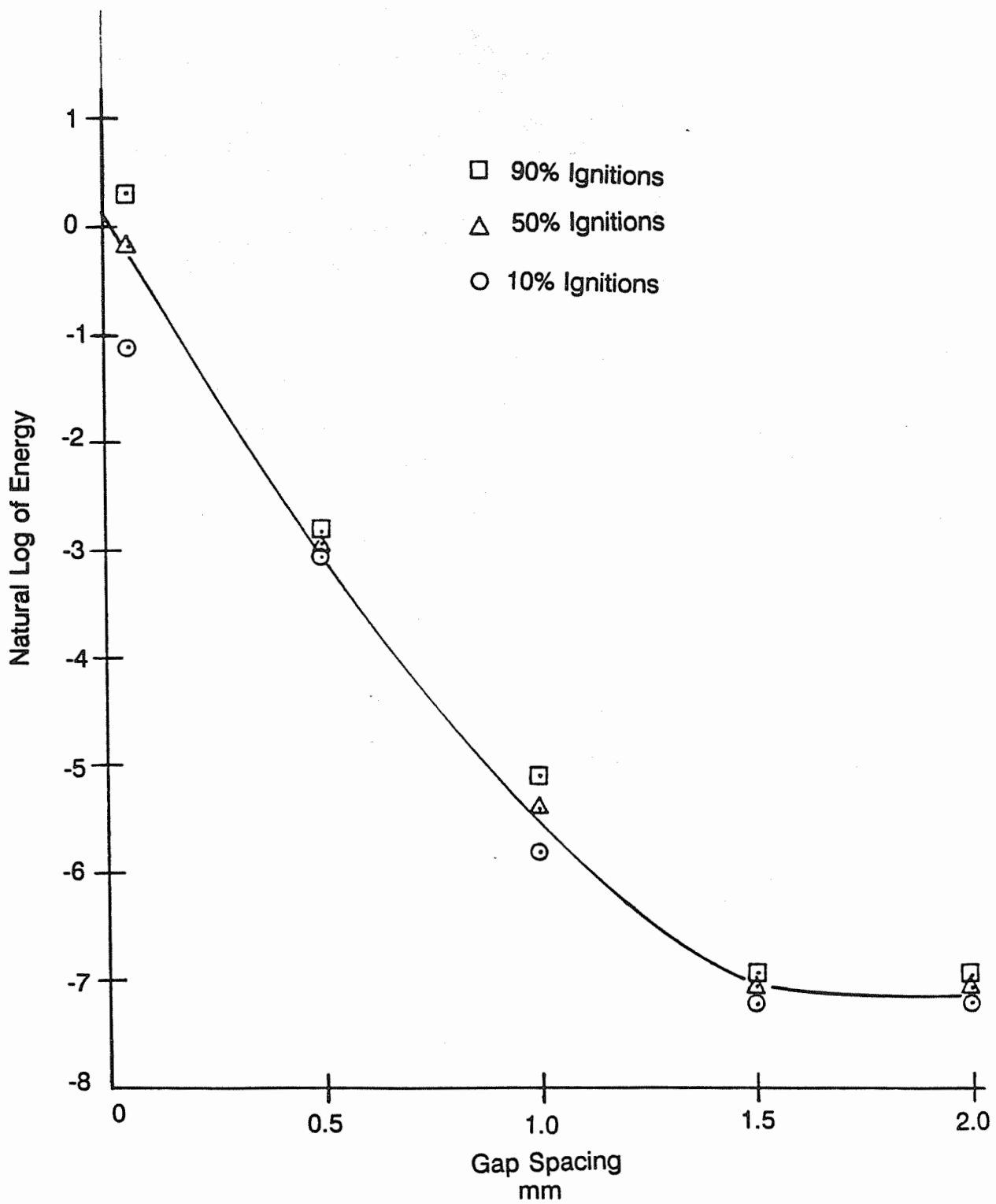
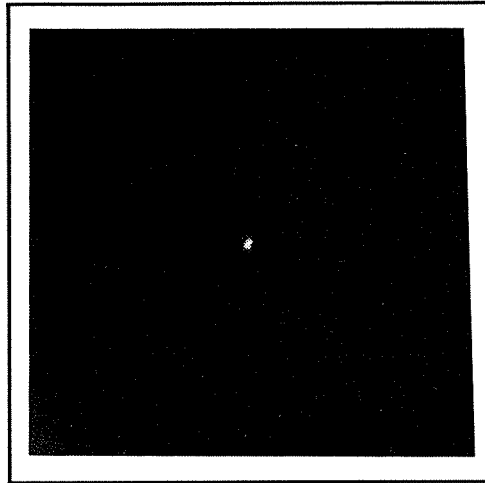
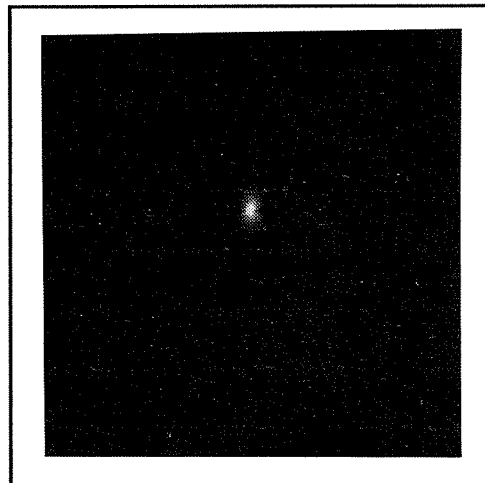

FIGURE 3. IGNITION ENERGY VS. GAP SPACING



Test No. 13
1.0 mm Gap
5 mJ Spark
ASA 1600
F 2.2



Test No. 15
0.5 mm Gap
36 mJ Spark
ASA 1600
F 2.2

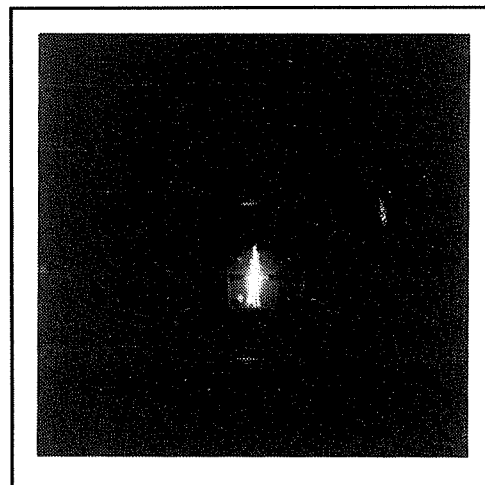

Test No. 18
0.05 mm Gap
277 mJ
ASA 1600
F 2.2

FIGURE 4. PHOTOGRAPHS OF NON-INCENDIARY THERMAL SPARKS

VOLTAGE SPARK SOURCE. The voltage spark source fixture used during the NADC program was rebuilt for use in the laboratory during general testing. Because of the questions surrounding the ceramic capacitors, an adjustable vacuum capacitor was installed and calibrated in the fixture to obtain more accurate spark energy data. Retests of the ignition energy probability of 1.2 stoichiometric propane and air were carried out and compared against the original NADC data. The tests were conducted using compressed air which contains 21% O₂. Table 3 gives the comparative data for the tests and Figure 5 shows the plots of both. Table 4 is a comparison of selected ignition probabilities versus energy which were taken from the plots.

The difference between the initial NADC plot and the interim plot of NADC data is caused by the variations in the two plots. The placement of the straight line through the points is a judgement made at the time it is drawn and will vary between people and even between times for the same person. The data between the two varies by an average of 11%. The plotting uncertainty is on the order of $\pm 5\%$.

The interim data shows the ignition energy to be an average of 32% lower than the re-plotted NADC data. This indicates that the original data may have had a 30% error which could have been related to the ceramic capacitors. It must also be noted that the effect of the change in O₂ percentage is not known.

FAA PROGRAM

After several years of inactivity, the FAA agreed to continue the work. The effort was organized into the following nine tasks.

- Task 1 - Program Development Test Plan
- Task 2-3 - Develop and Package a Thermal Spark Ignition Source
- Task 4 - Package Voltage Spark and Hot Spot Ignition Sources
- Task 5 - Develop Ignition Detection Test Technique(s)
- Task 6 - Prepare a Demonstration Test Plan
- Task 7 - Conduct and Document Demonstration Tests
Formulate Proposed Test Standard
- Task 8 - Conduct Industry Review (SAE Committee AE4L)
- Task 9 - Publish Proposed Test Standard and Final Report

These tasks were based on the perceived efforts required to complete the program started by NADC.

TABLE 3. COMPARISON OF IGNITION PROBABILITY VS. VOLTAGE SPARK ENERGY FOR ORIGINAL NADC TESTS AND LATER TESTS

Energy μJ	Ln (E)	Attempts (No.)	Ignitions (No.)	% Ignitions (Including Range)
NADC Data - Ceramic Capacitors - 20% O ₂				
550	-7.51	30	0	0-3
650	-7.34	9	2	20-22-30
750	-7.20	17	3	17-18-22
850	-7.07	26	14	52-54-56
950	-6.96	26	24	89-92-93
1050	-6.86	10	10	91-100
Interim - Vacuum Capacitor - 21% O ₂				
340	-7.99	20	0	0-5
420	-7.78	20	1	5-5-9
500	-7.60	20	9	43-45-48
660	-7.32	20	14	67-70-71
700	-7.26	20	19	91-95-95
850	-7.07	20	20	95-100

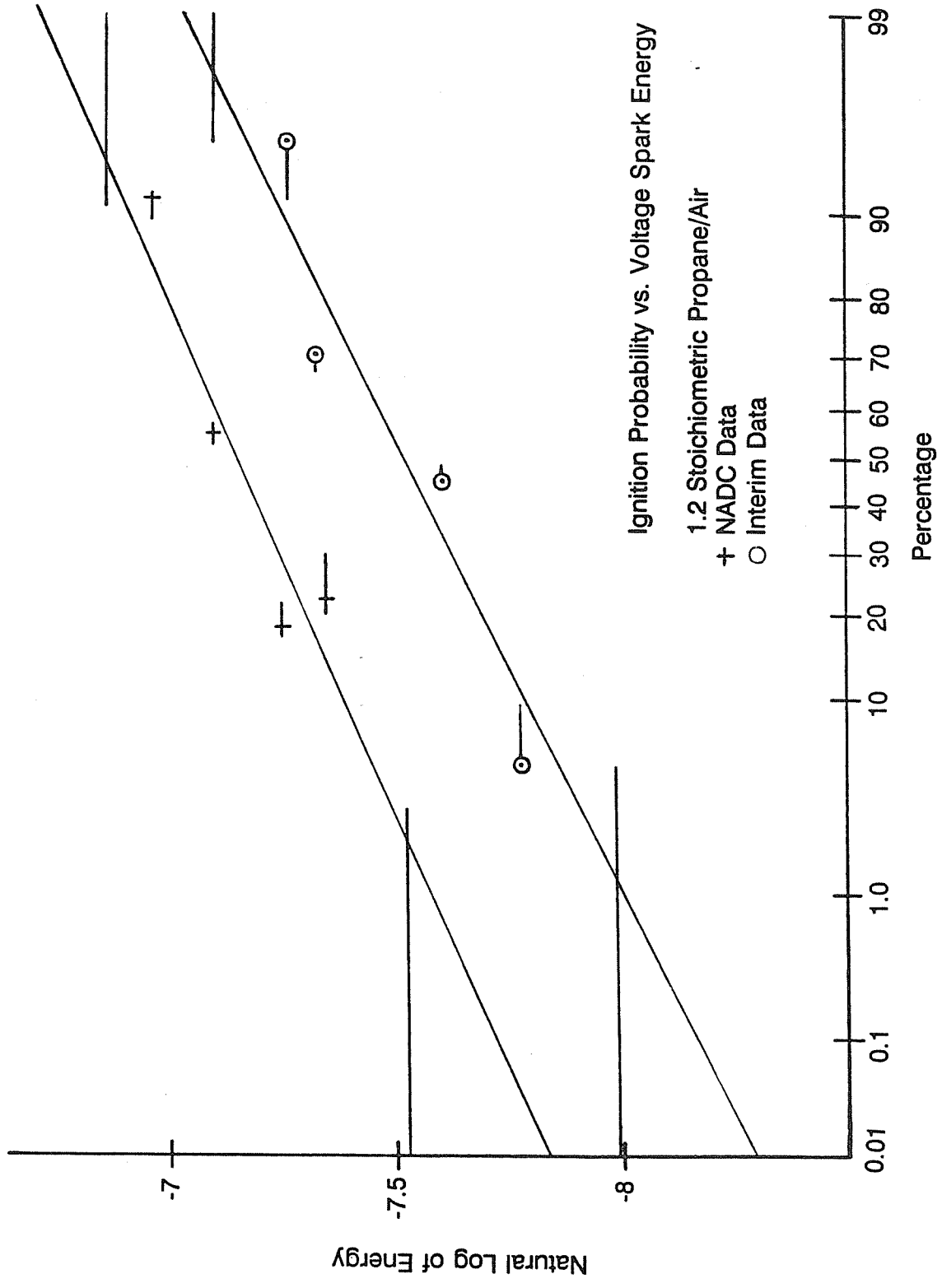

FIGURE 5. IGNITION PROBABILITY PLOTS OF NADC DATA AND INTERIM DATA

TABLE 4. COMPARISON OF IGNITION PROBABILITIES TAKEN FROM REPLOTS OF NADC AND INTERIM DATA

(1.2 Stoichiometric Propane)

0.01% (μ J)	0.1% (μ J)	1.0% (μ J)	10% (μ J)	50% (μ J)
NADC Program - 20% O ₂ Original Plot (See Table 1)				
440	485	550	645	710
Replot for Comparison				
395	440	430	625	785
Interim Data - 21% O ₂				
250	285	330	415	550

DEVELOPMENT TEST PLAN.

The anticipated approach and estimates of efforts are given in the report (Ref. 7). Several of the approaches outlined in the plan were later found to be unsuccessful.

DEVELOP AND PACKAGE A THERMAL SPARK SOURCE.

A major portion of the program effort was spent on the quest of a standard thermal spark ignition source (STISIS).

HOT PARTICLES. The initial thrust, heating of individual small particles and projecting them into the test volume, was unsuccessful for two reasons (Ref. 8).

Ref. 7 Crouch, K.E., *Aircraft Fuel System Lightning Protection Design and Qualification Test Procedures Development Test Plan*, Lightning Technologies, Inc. Test Plan No. LT-TP-92-83, dated May 1992.

Ref. 8 Crouch, K.E., *Aircraft Fuel System Lightning Protection Design and Qualification Test Procedures Development: Standard Hot Particle Ignition Source Progress Report*, Lightning Technologies, Inc. Report No. LT-93-882, dated January 1993.

First and foremost, it was determined that hot particles of the size observed in thermal sparks are not capable of fuel vapor ignition. Calculations and experiments with aluminum particles were carried out. The calculations showed that particles with sizes capable of releasing 500 μ J of energy at temperatures exceeding 900°C (the hot surface ignition temperature) would be on the order of 150 to 250 microns in diameter. Data from the literature indicated that ignitions occurred with particles of less than 100 microns. Calculation of energy released by burning particles indicated that diameters of 60 microns could supply sufficient energy to ignite. Various experiments and articles in the literature confirmed that the incendiary particles were burning.

Second, it was found physically impossible to handle the small particles with any reasonable apparatus. It was found during the work with the small particles (actually spherical metal powders) that the spheres adhered to one another. The attraction appeared to be a strong electrostatic force that resulted in larger particles having small ones attached to them. The attachment was not physical as they could be parted with a knife edge, at which point they repelled one another. They also appeared to move around one another as they were rolled. The reason for the attraction and a method of separating them was not found. It was not possible to work with a single particle.

GRAPHITE/WIRE CONTACT. When a length of fine wire is subjected to the appropriate level and duration of current, the energy deposited will melt and vaporize the wire. If the wire is perfectly uniform and homogenous, the entire length of wire will melt and/or vaporize at the same time. In reality, there will be imperfections such that some portions will react before the rest. The size of particles generated by an exploding wire will then depend on the uniformity of the wire and will be different for each test conducted.

The objective for a thermal spark source is to consistently generate burning particles of controllable size. If the current transitions to another material of higher resistivity, then the heat will be generated at the interface. The end of a wire uniformly contacting a graphite (carbon) surface meets these objectives. Calculations and plans were developed to investigate what equipment would be needed to explore this approach (Ref. 9).

Generation of small particles would best be attempted by using small components, i.e. fine wires. Using some very preliminary tests as a starting point, calculations of the probable current levels and durations necessary to melt/vaporize aluminum, stainless steel and titanium wires 0.001 to 0.005 in. in diameter were made. From these predictions, equipment and procedures needed to conduct such tests were developed. The controlled parameters anticipated included contact pressure, current magnitude, pulse duration, wire material, and wire diameter.

Ref. 9 Crouch K.E., *Status Report: Thermal Spark Ignition Source*, Lightning Technologies, Inc. Report No. LT-93-948, dated April 1993.

EXTERNAL SOURCES. The graphite/wire interface concept entailed the acquisition or the fabrication of several items of equipment. Before embarking on that route, other approaches were evaluated to see if less complicated means could achieve the objective. One of the approaches considered for introducing burning particles of a specific size into a fuel/air volume was to generate the particles outside of the chamber and pass them through a screen filter which limited the maximum size which could enter (Ref. 10). Burning particles were generated using abrasion, electrical current pulses through contacting conductors in motion (spinning), wires exploded with current pulses, and crossed wires subjected to current pulses.

The screens used were made of metalized monofilament polyester and the particles burned holes in the screen allowing larger particles to enter. Also, fuel/air vapors escaping through the screens were ignited outside of the chamber. Although the above two problems did not appear to be insurmountable, none of the particles generated had a sufficient range of motion to penetrate the screens for any significant distances. This drawback appeared to be insurmountable. Examples of the generation of these sparks are shown in Figures 6, 7, 8, and 9.

WIRE/CARBON CONTACT. The wire/carbon interface approach for generating thermal sparks can be placed inside a test volume. This eliminates the particle travel problem associated with the external sources considered above. The other two ignition sources, the SVSIS and the SHSIS, are internal sources since the active elements are operated inside the test volume.

When the external thermal spark source investigations yielded no easy solutions, work was resumed on the wire/carbon approach (Ref. 11). Equipment to hold and transfer currents to small wires and rods of carbon were required. Mechanical pencils appeared to provide a solution for the carbon side in that a 0.3 mm (300 micron) pencil existed. A small pin vice was used hold the wires. These two components were then to be mounted with a micrometer movement positioning device which could control the contact.

Ref. 10 Crouch, K.E., *Aircraft Fuel System Lightning Protection Design and Qualification Test Procedures Development Progress Report: Thermal Spark Ignition Source*, Lightning Technologies, Inc. Report No. LT-93-967, dated August 1993.

Ref. 11 Crouch, K.E. and J.E. Pryzby, *Aircraft Fuel System Lightning Protection Design and Qualification Test Procedures Development Progress Report: Hot Spot Ignition Source, Thermal Spark Ignition Source, Gaseous Defection Techniques, Optical Detection Techniques*, Lightning Technologies, Inc. Report No. LT-93-999, dated November 1993, pp. 3-5.

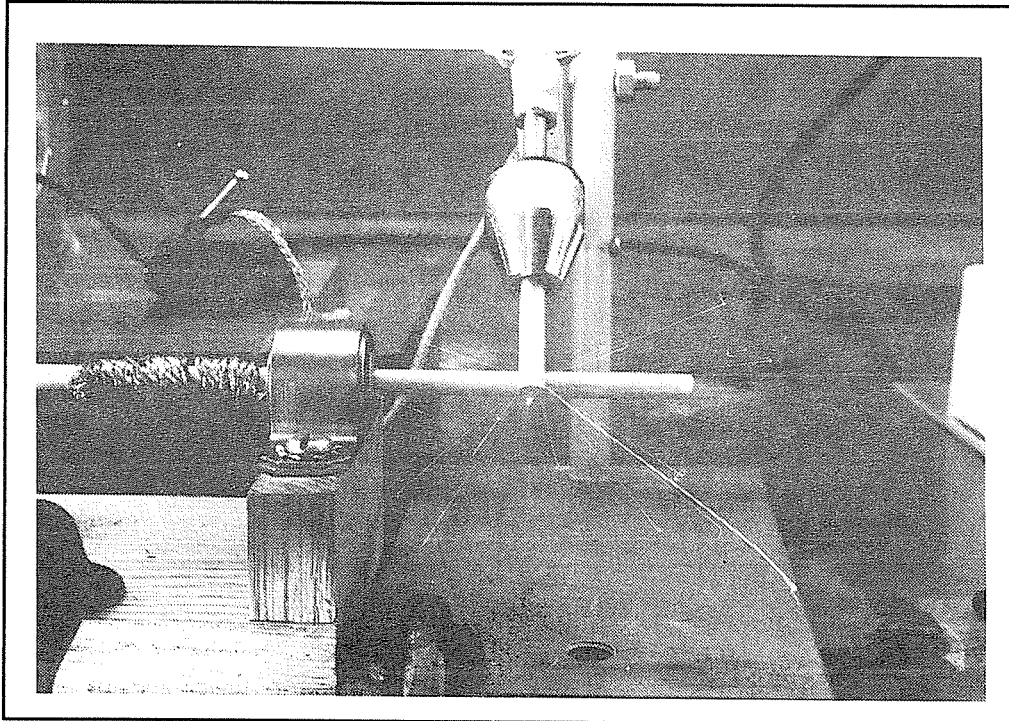

Test No. 9

Rotating Electrode: Aluminum
Stationary Electrode: Aluminum

$I_{pk} = 1,300 \text{ A}$
Speed: Low

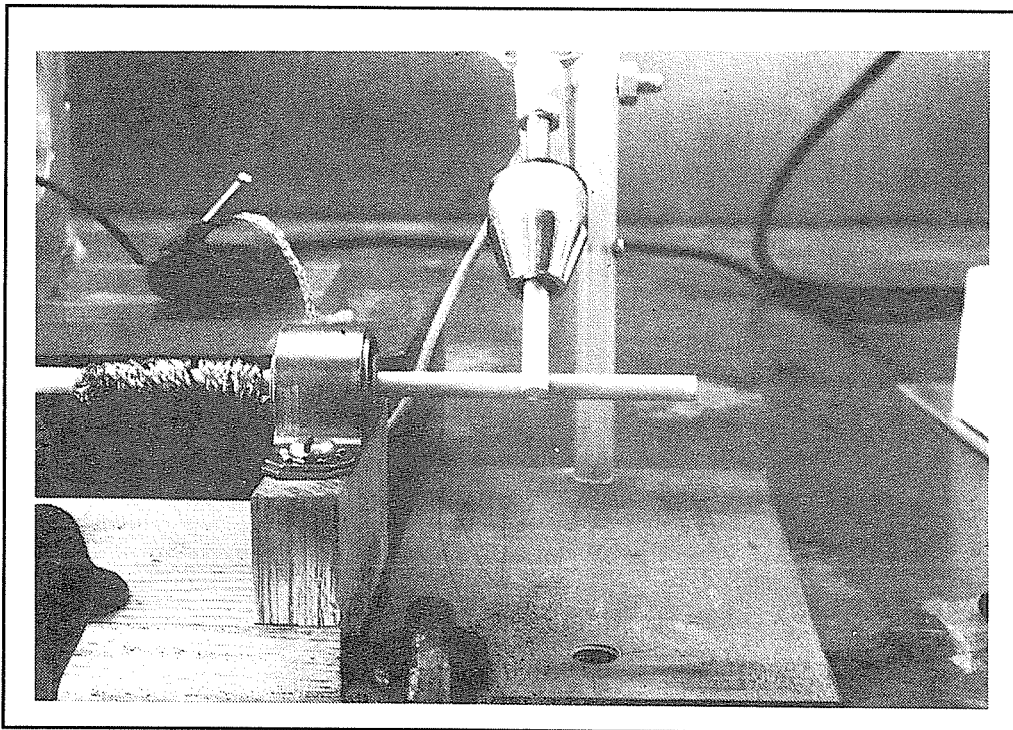

Test No. 12

Rotating Electrode: Aluminum
Stationary Electrode: Aluminum

$I_{pk} = 1,300 \text{ A}$
Speed: Low

FIGURE 6. TYPICAL ROTATING ELECTRODE TESTS

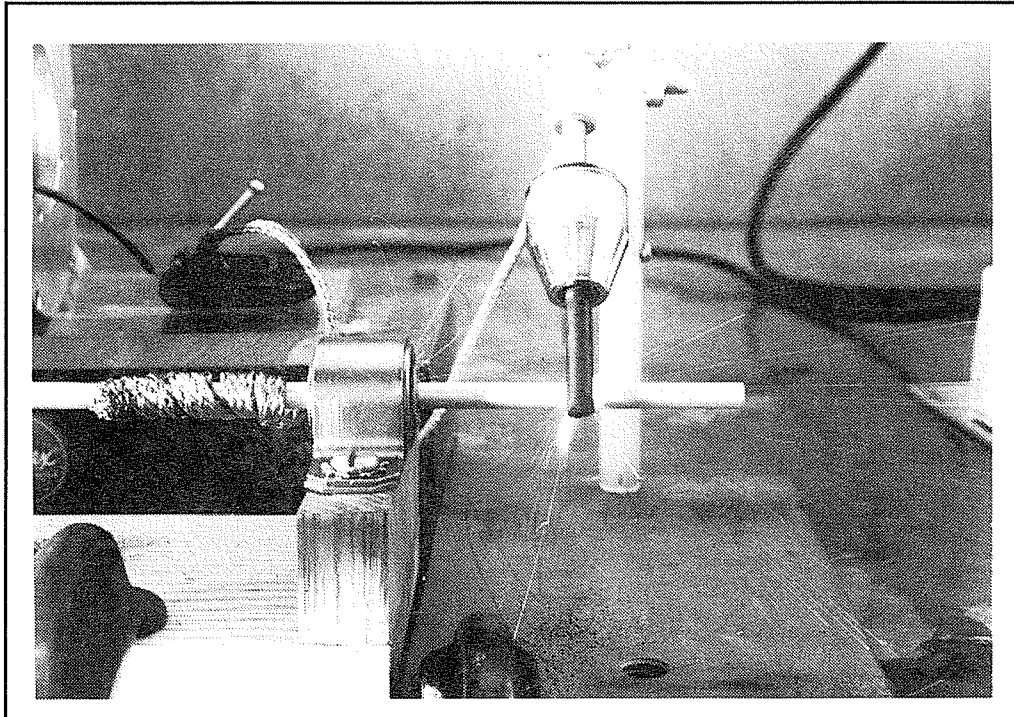

Test No. 5

Rotating Electrode: Aluminum
Stationary Electrode: Graphite

$I_{pk} = 1,300 \text{ A}$
Speed: High

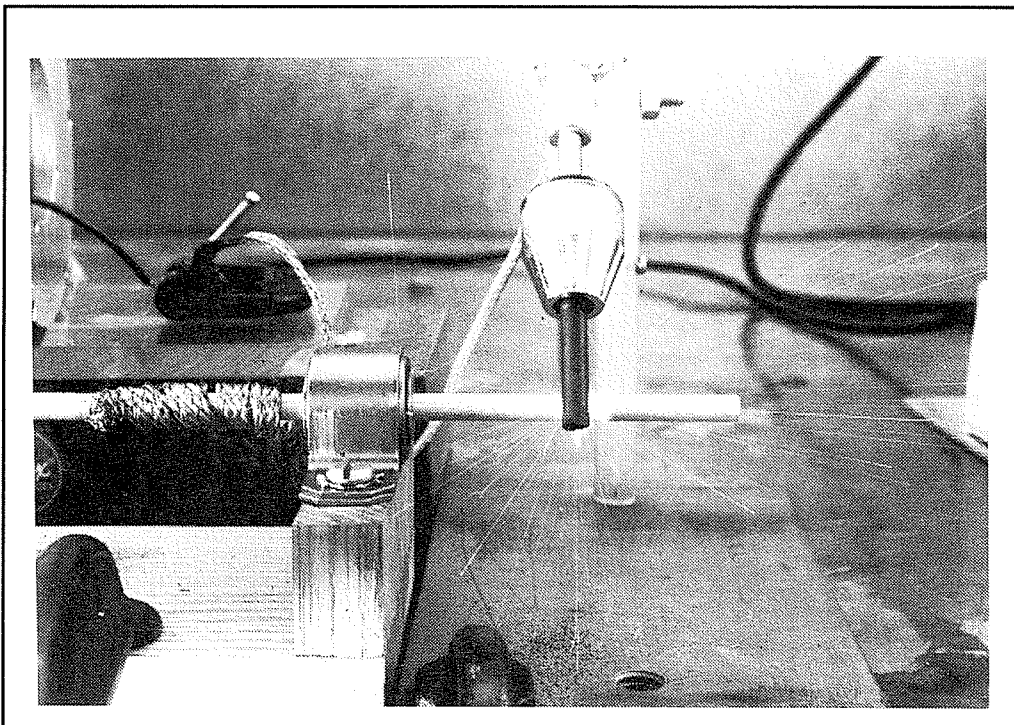

Test No. 9

Rotating Electrode: Aluminum
Stationary Electrode: Graphite

$I_{pk} = 1,300 \text{ A}$
Speed: High

FIGURE 7. TYPICAL ROTATING ELECTRODE TESTS

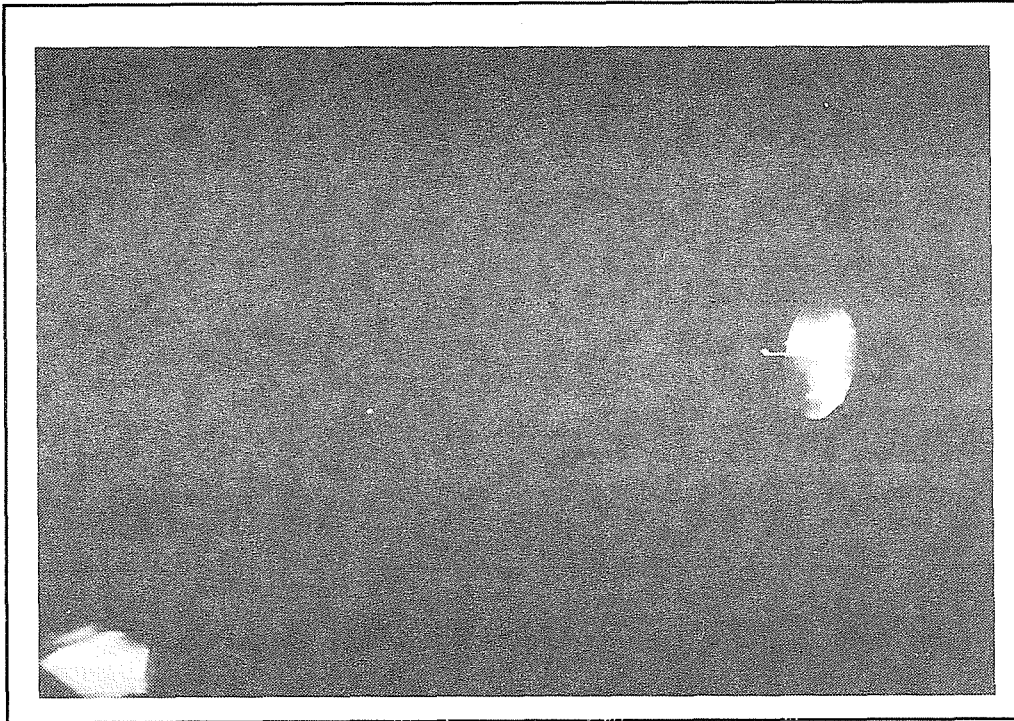

0.005 dia.
Aluminum
Test 5
No Ignition

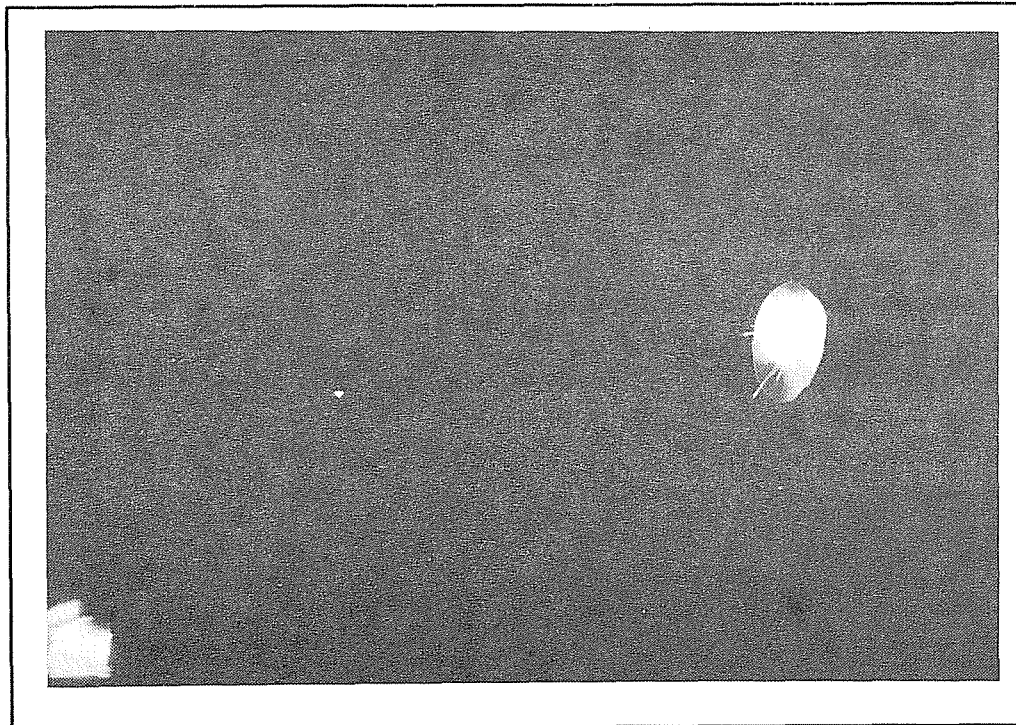

0.005 dia.
Aluminum
Test 6
No Ignition

FIGURE 8. EXPLODING WIRE PARTICLES ENTERING THE CHAMBER

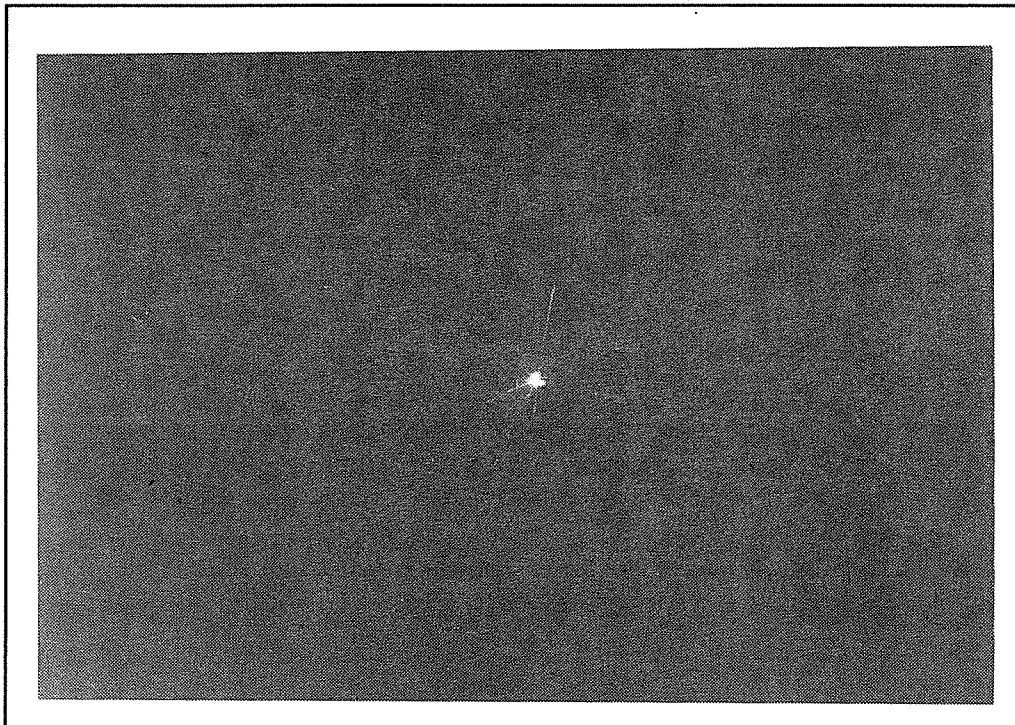
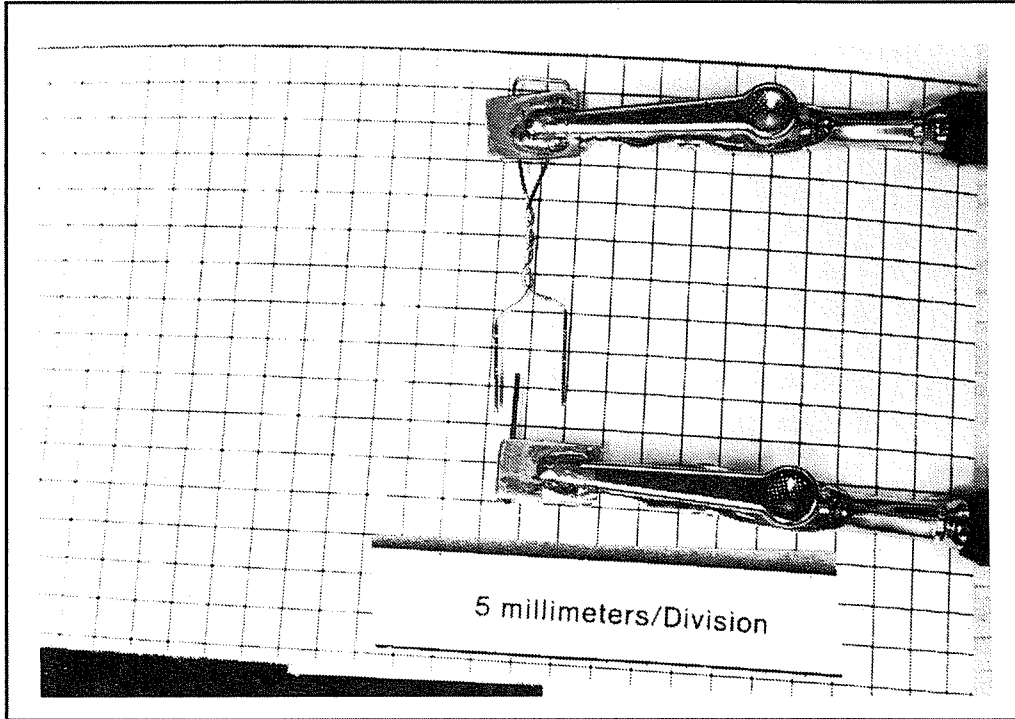

FIGURE 9. SECOND CROSSED WIRE FIXTURE AND THERMAL SPARK SHOWER

Tests on the pencil leads found that they are composed of an oil and graphite (carbon). The hardness of the lead is determined by the baking temperature. The higher the bake temperature, the harder the lead. The composition is roughly 70% carbon and 30% oil product. Unfortunately, when the interface contact point between the wire and the pencil lead is heated by a current pulse, the oil boiled before the wire melted. The vaporized oil caused the surface of the pencil lead to explode, ejected the carbon material in the area and started an arc between the wire and the carbon in the gap between the two. To work properly, the carbon must be pure enough to remain mechanically stable up to the vaporization temperature of the wire.

Arc welding carbon cutting rods were found to be pure enough carbon to meet these requirements. These rods were available in 5/32 in. dia. and had to be machined to 0.040 in. dia. to fit the pin vises used in the fixture.

Fine aluminum and titanium wires, 0.001, 0.003 and 0.005 in. dia. were purchased for the fixture. The wires were cut into 1/2 in. lengths and hand installed in the pin vise. The smallest vise found had jaws that would hold a 0.040 in. dia. rod when fully open. When screwed down on the 0.001 to 0.005 wires, the jaws pinched the wires at the jaw tips, and two things happened. First, the wires protruded at an angle with respect to the center line, and second, the jaw tips tended to cut the wires, especially the soft aluminum wire.

In order to get reproducible results, the contact interface between the wire and the carbon must be controlled. The calculations made were based on the assumption that the current in the wire was conducted to the carbon over the entire cross sectional surface of the wire. If only 50% of the surface was actually in contact with the carbon, the same current level would cause the temperature level to be almost twice as high. Both surfaces must be flat and smooth. The graphite surface could be polished by holding it perpendicular and rubbing it on a paper. It was not possible to work with the wires because of their small size. A razor blade was used to cut the wire and it was held in a manner which attempted to provide a flat surface on the wire. After cutting, the wire was inspected in a 20X microscope.

In the initial investigations, it was noted that the contact pressure may need to be controlled to insure repeatable thermal spark generation. Equipment to monitor small pressures (10's of grams) in this environment presented a formidable task. Instead, it was decided to monitor contact resistance, as measured by a simple ohmmeter. It was found that many times when contact was made, the value would change considerably when the operators' finger contact with the micrometer was released. This indicated that the system contained enough backlash to allow very small displacements to occur. Unfortunately, those small displacements could significantly change the nature of the contact between the wire and the carbon. An installation method allowing for small displacements at a constant force was needed to insure consistent contact between the wire and the carbon.

The most promising approach for generating controlled, repeatable thermal sparks appears to be the wire/carbon interface. Equipment necessary to determine if a standard thermal spark ignition source (STISIS) could be developed from this approach was assembled and tried out (Ref. 12). The results of this work is given in Appendix A. Photographs and descriptions of the investigations are given there.

The important parameters to control the process appear to be:

- Wire material
- Surface treatment of both the wire and the carbon
- Contact alignment
- Contact pressure
- Current duration
- Current magnitude

In the work done so far, the results have not been consistent enough to attempt any ignition tests. Once these problems have been solved, tests to correlate ignition probability to thermal spark level can be conducted. This data can then be used to characterize the ignition detection techniques.

STANDARD VOLTAGE SPARK IGNITION SOURCE.

Using the techniques and procedures developed and verified during the NADC program and the Interim experience, a standard voltage spark ignition source (SVSIS) was designed, built, and verified. The complete design is documented and presented in Appendix B (Ref. 13). Complete documentation for assembling and operating the SVSIS including cautions is provided.

The design uses very high resistances to isolate and control the spark rate of the fixture. The electrode holders and variable capacitor must be clean and dry to operate properly. Experience at LTI has shown that, although there were times when the system needed to be cleaned and dried, it was possible to use in almost any laboratory environment.

Ref. 12 Crouch, K.E., *Aircraft Fuel System Lightning Protection Design and Qualification Test Procedures Development: Standard Thermal Spark Ignition Source*, Lightning Technologies, Inc. Report No. LT-93-970 Revision A, dated August 1993.

Ref. 13 Crouch, K.E., *Aircraft Fuel System Lightning Protection Design and Qualification Test Procedures Development: Standard Voltage Spark Ignition Source*, Lightning Technologies, Inc. Report No. LT-92-854 Revision A, dated August 1993.

STANDARD HOT SPOT IGNITION SOURCE.

The concept for the standard hot spot ignition source (SHSIS) was developed during the NADC program, but the details of packaging, control, and monitoring had to be completed during the FAA program. The major technical achievement to be completed was monitoring and controlling the hot spot foil temperatures. Initially the temperature was observed using an IR diode. Commercial optical pyrometers, which use the same principles, average the readings over several seconds. The event of interest only lasts a second and a time record is desired. Unfortunately, optical measurements depend on the surface conditions of the material and work best on "black body" materials. Reflective surfaces, such as the stainless steel foils, will transmit reflected IR radiation along with that generated by the material surface temperature. Although optic measurements appeared to hold promise for such measurements, in this particular instance, the problem appeared to be insurmountable.

Fine wire thermocouples (0.002 in. dia.) were found to have acceptable response when spot welded to the foils (Ref. 14). A set of tests was conducted which verified that the NADC data (900°C) agreed with the new measurements

The final design is documented and presented in Appendix C (Ref. 15). Complete assembly and operating instructions are included.

IGNITION DETECTION TECHNIQUE DEVELOPMENT.

The ignition detection technique(s) are used to evaluate whether or not a particular fuel system lightning protection design meets the pass/fail criteria established for that application. The ability of the ignition detection technique to identify the level of protection provided is verified by the standard ignition sources. The technique(s) must be practical, easy to use and repeatable. They must also be able to determine the margin of success or failure for the established pass/fail criteria.

Two approaches were undertaken, photographic and combustible vapors. The photographic technique built on the techniques presently used in industry. The combustible vapor technique uses mixtures of gases to attain greater or lower sensitivities of ignition than that of propane/air, which is considered to represent the environmental threat.

Ref. 14 Crouch, op. cit., LT-93-999, pp. 1-3.

Ref. 15 Crouch, K.E., *Aircraft Fuel System Lightning Protection Design and Qualification Test Procedures Development: Standard Hot Spot Ignition Source*, Lightning Technologies, Inc. Report No. LT-92-855 Revision B, dated January 1994.

PHOTOGRAPHIC IGNITION DETECTION TECHNIQUE (PIDT). The original technique as described in MIL-STD-1757 and AC 20-53 utilized an ASA 3000 speed Polaroid film and an f/4.7 lens. When used to view 200 μ J sparks, this combination of lens opening and film speed is very marginal (Ref. 16). Imperfections in the film and/or negative will often be larger than the spark image. The use of 35 mm cameras with higher speed films and larger apertures does reduce such problems.

The ability to relate image size to voltage spark ignition probability was explored, but appeared to be subject to error levels of nearly $\pm 100\%$. Attempts to correlate density and size of a hot spot image on the film were not successful, largely due to the small image size. Without some pre-knowledge of the ignition source under observation, light recorded by the photographic technique can only be used to indicate the possibility of an ignition source in that region.

Suggested procedures and interpretation methods to evaluate the photographic techniques are given in Appendix D. Validation test results are also included (Ref. 17).

COMBUSTIBLE VAPOR IGNITION DETECTION TECHNIQUE (CVIDT). The combustion of stoichiometric propane/air mixtures has been taken to represent the actual threat present in an aircraft fuel system. Propane/air detection has only been used in areas where the photographic technique was obviously inadequate. These areas included translucent structures, complex structures where potential ignition sources could not be seen, or where multiple mirrors would be required to view the potential source.

The statistical nature of propane/air voltage spark ignitions has been ignored. Tests using propane/air detection were considered to have passed if no ignitions occurred during a single test. When cameras were also used, the presence of visible light sources raised questions about both ignition detection techniques. The use of propane/air as a detection technique was restricted at many facilities because of the explosive nature of the test.

Stoichiometric propane/air ignitions can develop pressures exceeding 150 psi and temperatures exceeding 1500°C when confined. Since laboratory test chambers and aircraft fuel systems cannot withstand such conditions, the burn must be vented. This results in flames of several feet exiting the test chamber. For these reasons, many laboratories are reluctant to use propane/air mixtures.

Ref. 16 Crouch, op. cit., LT-93-999, pp. 8-13.

Ref. 17 Pryzby, J.E., *Aircraft Fuel System Lightning Protection Design and Qualification Test Procedures Development: Photographic Ignition Detection Techniques*, Lightning Technologies, Inc. Report No. LT-94-1032 Revision A, dated April 1994.

Sensitive Fuels. More sensitive fuels, ones that ignite at ignition energy levels lower than propane and can be used in low concentrations, could be mixed to ignite at preset energy levels that result in lower pressures and temperatures. Investigations into hydrogen and other low ignition level gases found that such a detection mixture was possible (Ref. 18). From the literature, low concentration mixtures of hydrogen, oxygen, and argon would appear to yield a detection mixture which would be very sensitive and result in low pressures since the energy released by the low concentration of hydrogen will be small. Figure 10, taken from Lewis and Von Elbe (Ref. 19) shows ignition energies of hydrogen for various inert gases at various concentrations. This curve was the starting point for the development sensitive, low pressure ignition detectors.

From the curve, it appears that a 7% hydrogen, 21% oxygen, and 72% argon should result in a mixture that has a minimum ignition level of 100 μ J. At that concentration, the pressure should be 1/4 that of a stoichiometric mixture. Tests using this amount of hydrogen were conducted and the ignition energies obtained are given in Table 5. A plot of the data is given in Figure 11, and the ignition probabilities taken from the plot are shown on Table 6.

Ref. 18 Crouch, op. cit., LT-93-999, pp. 5-8.

Ref. 19 Lewis, Bernard, and Guenther Von Elbe, *Combustion, Flames and Explosions of Gases*, Third Edition, Academic Press, 1987, p. 347.

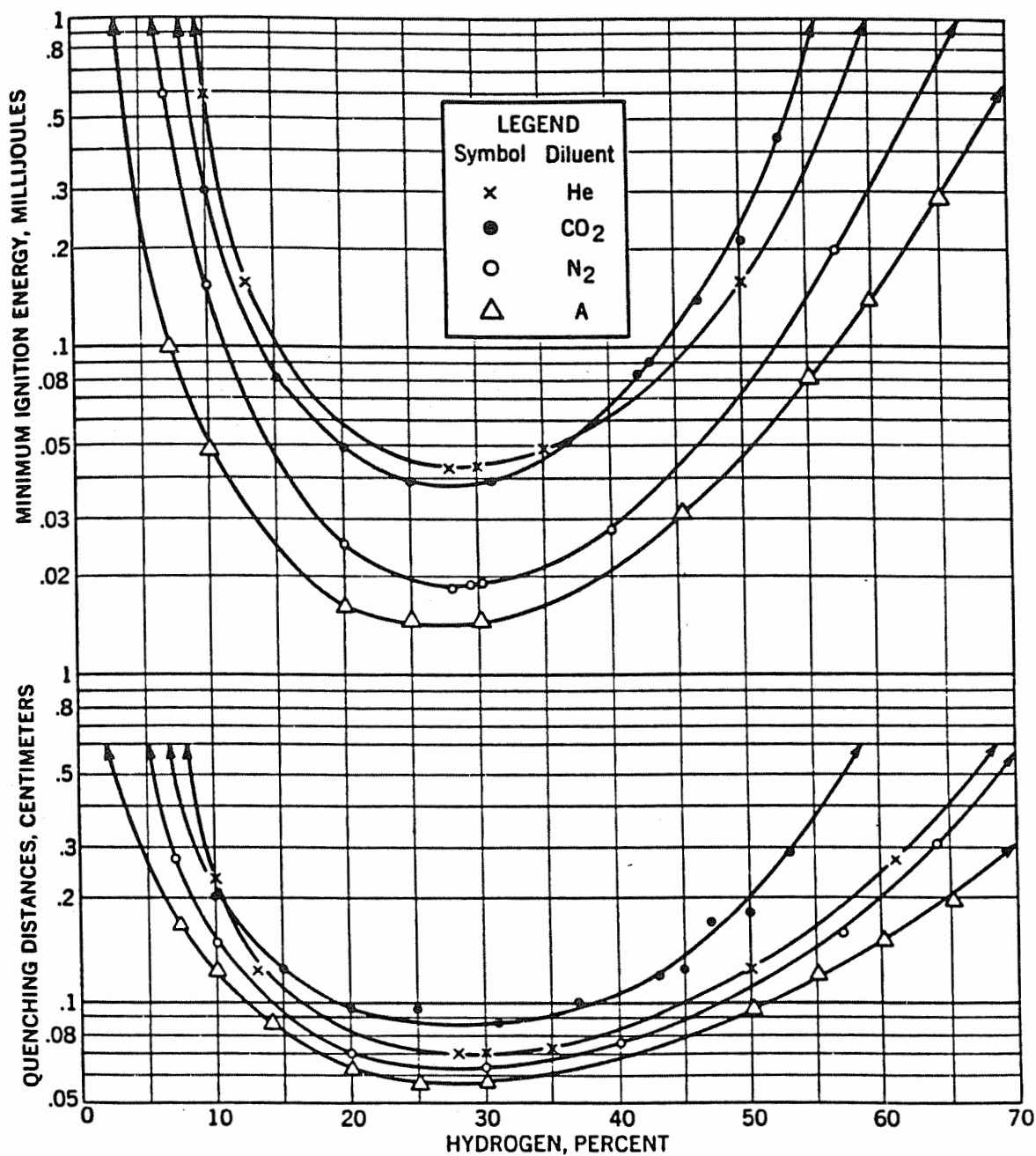

FIG. 173. Minimum ignition energies and quenching distances for hydrogen-oxygen-inert gas mixtures at atmospheric pressure. $O_2/(O_2 + \text{inert gas}) = 0.21$.

FIGURE 10. FROM LEWIS AND VON ELBE

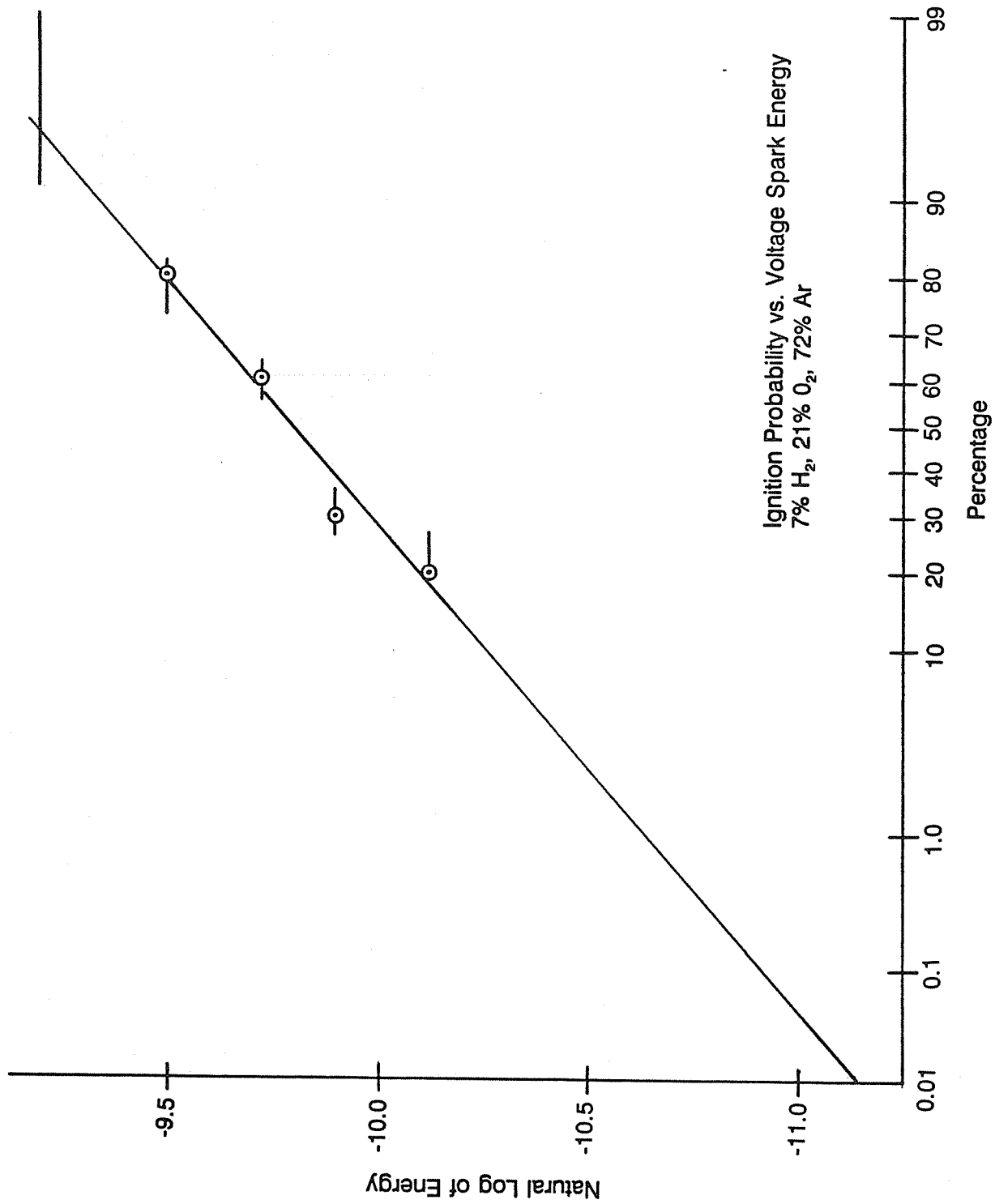

FIGURE 11. IGNITION PROBABILITY PLOT OF H₂ - O₂ - Ar DATA, (7% H₂, 21% O₂, 72% Ar)

TABLE 5. IGNITION PROBABILITY OF HYDROGEN (7%), OXYGEN (21%) AND ARGON (72%) AS A FUNCTION OF VOLTAGE SPARK ENERGY

Energy μJ	Ln (E)	Attempts (No.)	Ignitions (No.)	% Ignitions (Including Range)
40	-10.13	10	2	18-20-27
50	-9.90	10	3	27-30-36
60	-9.72	10	6	55-60-64
75	-9.50	10	8	73-80-82
100	-9.21	10	10	91-100

TABLE 6. IGNITION PROBABILITIES TAKEN FROM PLOT (FIGURE 11)

0.01% (μJ)	0.1% (μJ)	1.0% (μJ)	10% (μJ)	50% (μJ)
15	20	25	35	55

This data is plotted following the same format as in the earlier NADC and Interim data. It should be noted that the slope of the line in Figure 11 is steeper than observed in the earlier plots. The data indicates that the 7% hydrogen mixture has voltage spark ignition energies which are an order of magnitude less than propane/air. This is much lower than indicated by the Lewis & Von Elbe curve which gives a value about one half of the propane/air energy.

The pressures observed using 7% hydrogen were significantly less than that of a propane burn. Although no pressure measurements were made, the hydrogen burn time was much longer than stoichiometric propane, and often did not rip the aluminum foil covering the chamber blow out port.

The exercise did prove that more sensitive mixtures can be developed with variable voltage spark ignition energy levels and very low pressures.

A description of procedures that can be used to mix sensitive fuels as ignition detectors is given in Appendix E (Ref. 20).

Ref. 20 Crouch, K.E., *Aircraft Fuel System Lightning Protection Design and Qualification Test Procedures Development: Combustible Vapor Ignition Detection Technique*, Lightning Technologies, Inc. Report No. LT-94-1031 Revision A, dated April 1994.

DEMONSTRATION TEST PLAN.

After development of the standard ignition sources and the detection techniques, tests were to be conducted on fuel system components to illustrate the application of the techniques. Initially it was proposed that the demonstration tests be conducted jointly by several lightning laboratories. Demonstration test procedures were prepared to insure that all tests would be conducted in a similar manner (Ref. 21).

DEMONSTRATION TESTS.

It was not possible to conduct tests using other laboratories, so all demonstration tests were conducted at Lightning Technologies, Inc. Also, in the test plan it had been anticipated that some of the test articles would be furnished at no cost by aircraft manufacturers. Such test articles were not available and substitutions had to be made (Ref. 22).

Tests were applied to typical fuel system components and structures during which the proposed test procedures were evaluated and their use demonstrated. The tests were conducted on aluminum fuel structures and on carbon fiber composite (CFC) structures. The test items included:

- Skin materials
- Fuel quantity probes
- Flexible fuel line couplings
- Fasteners

Engineering design tests often utilize panel or coupon type test items. The coupon type samples are convenient to use, relatively inexpensive to fabricate and can be designed to investigate only one or two aspects of a protection design at a time, i.e., skin material, fastener installation, or joint design. Through proper design of the test items, all aspects of a complete protection design can be verified.

Ref. 21 Crouch, K.E., *Aircraft Fuel System Lightning Protection Design and Qualification Test Procedures Development: Phase II Demonstration Test Procedures*, Lightning Technologies, Inc. Report No. LT-93-1009, dated December 1993.

Ref. 22 Crouch, K.E., *Aircraft Fuel System Lightning Protection Design and Qualification Test Procedures Development: Demonstration Test Report*, Lightning Technologies, Inc. Report No. LT-94-1037, dated April 1994.

Qualification tests are conducted to verify that a design is adequate and can be fabricated. Qualification tests are often performed on entire assemblies. Such test items may be quite complex, containing many joints, fasteners, materials, ribs, spars, and access doors, each of which could include an ignition source.

The demonstration tests were conducted using coupon/panel type samples selected to exhibit each of the various ignition hazards. The samples were configured to fit the LTI fuels test chamber.

SUMMARY.

The results of the demonstration tests are summarized in the following paragraphs.

Materials Evaluation (Hot Spots). Tests on aluminum and titanium panels caused hydrogen vapor ignitions at what appears to be the same coulomb levels reported by Oh and Schneider (Ref. 23). Figures 12 and 13 show the demonstration data points plotted on the earlier data. It appears that the hydrogen is no more sensitive than propane. This conclusion does appear consistent with the NADC hot spot data that indicated no fuel dependence on the 900°C ignition level.

Tests on the CFC panels resulted in no ignitions at coulomb levels of 200 C. The thermal conductivity of graphite is such that incendiary temperatures cannot be conducted to the inside of the material. The resin will boil off at temperature levels less than 300°C, so the inner side temperature can not reach incendiary levels until the resin has been removed. At that point the material will have been destroyed and a puncture or hole will be present. Ignition will result since the vapors are exposed to the electrical arc.

The photographic data did not yield any definitive indications of ignition status. Light was recorded for each of the ignitions observed in the hydrogen, and none was observed when the hydrogen did not ignite.

Fuel Probe (Voltage Spark). The hydrogen vapor ignited and light was observed for all of the tests applied. The spark energies were from 200 to 700 μ J, which greatly exceeds the ignition levels required to ignite the hydrogen vapors.

Fuel Line Couplings (Thermal Spark). Typical fuel line couplings were subjected to current component "B" pulses of 450 A to 750 A. Ignitions occurred at all levels with visible light noted on the photographs. Tests on the same couplings in a propane/air atmosphere resulted in ignitions and light at levels above 750 A, and light only at 750 A.

Ref. 23 Oh, L.L. and Schneider, S.D., *Lightning Strike Performance of Thin Metal Skins*, Proceedings of the 1975 Conference on Lightning and Static Electricity, Culham Laboratory, England, 3-5 December 1975.

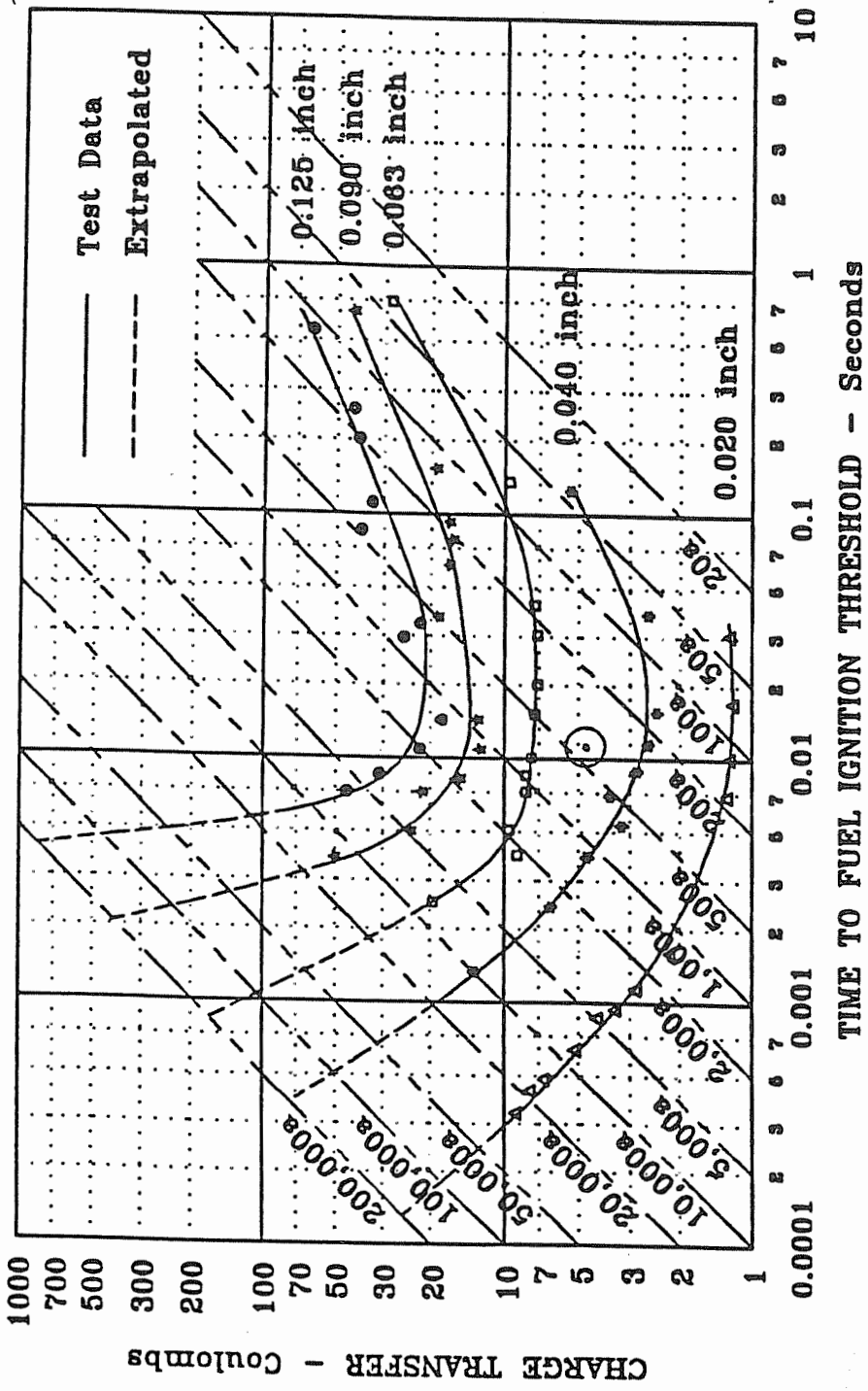

○ Demonstration Test Data Point

Coulomb meltthrough and ignition threshold for aluminum skins (2024 T3).

FIGURE 12. FROM OH & SCHNEIDER

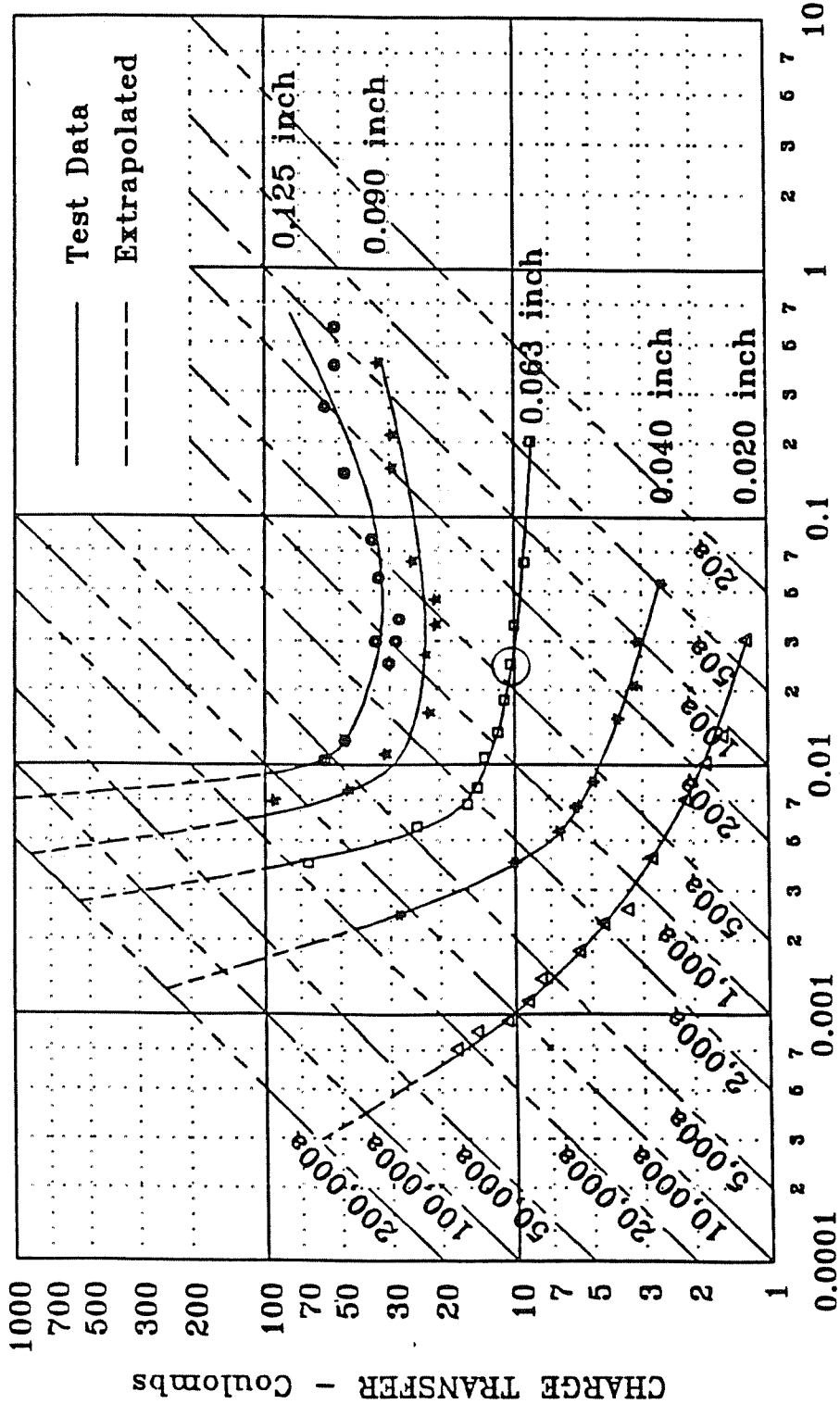

Coulomb hot spot and ignition thresholds for titanium skins (6AL4V).

○ Demonstration Test Data Point

FIGURE 13. FROM OH & SCHNEIDER

Fasteners (Thermal Spark). In the aluminum panel, no ignitions and no light were noted at 100 kA.

The hydrogen vapor ignited at levels of 12 kA and above on the graphite panel. No ignitions occurred from 6 kA to 12 kA. Light was observed at all applied current levels.

INDUSTRY REVIEW.

On March 10, 1994, a complete review of the program was presented to the SAE Committee AE4L during their meeting at Washington D.C. Copies of the pertinent reports and a viewgraph summary were discussed with the members.

PROPOSED TEST STANDARD.

EUROCAE WG-31 AND SAE AE4L are presently working on an Aircraft Lightning Test Standard which provides guidance for feasibility and verification testing. The document will replace References 2 and 3.

The results of this program were formulated into a proposed test standard using the WG-31/AE4L format and submitted for consideration by the committees. A copy of the proposal is given in Appendix F (Ref. 24).

The most important aspects of the proposed test standard are the incorporation of a method for the manufacturer to logically establish a pass/fail criteria and methods of ignition detection that will measure the margin by which the design meets the criteria.

The use of photographic and video images has been incorporated into the CVIDT to assist in identifying the sources of ignition.

CONCLUSIONS AND RECOMMENDATIONS

Although significant progress was made in the development of improved test techniques and procedures, as described in this report, some areas could still use further efforts.

THERMAL SPARKS. The work done here has identified approaches which could be used to develop a method of generating controlled spark levels. If the approach works, then ignition tests which will define ignition thresholds could be carried out and the calibration of the detection techniques could increase the technique usefulness.

Ref. 24 Crouch, K.E., *Aircraft Fuel System Lightning Protection Design and Qualification Test Procedures Development: Proposed Test Standard*, Lightning Technologies, Inc. Report No. LT-94-1055, dated April 1994.

PHOTOGRAPHIC DETECTION TECHNIQUE. As a technique, still photographs do not provide information on the probability of ignition of voltage sparks, and no information on hot spots. In both cases, the type of ignition source must be identified before an assessment of the ignition level can be made.

Investigations of other films which have response outside the visible range, such as ultraviolet (UV) or infrared (IR), should be made to see if better results can be attained.

COMBUSTIBLE VAPOR IGNITION DETECTION TECHNIQUE. The hydrogen vapor mixture turned out to be an order of magnitude more sensitive to voltage sparks than expected. During the burn, the hydrogen did not emit any visible light and detection of the source by video cameras was difficult. Other mixtures and methods of increasing the visibility of the burn would make the technique more usable.

A set of mixtures with specified sensitivities corresponding to recommended pass/fail levels should be established and verified. These mixtures would also be used to verify margins attained by a protection design. Also, data on the reaction to hot spots and thermal sparks is needed to confirm the usefulness of the technique.

APPENDIX A

LT-93-970

**AIRCRAFT FUEL SYSTEM LIGHTNING
PROTECTION DESIGN AND
QUALIFICATION TEST PROCEDURES
DEVELOPMENT
STANDARD THERMAL SPARK
IGNITION SOURCE**

Prepared by:



K. E. Crouch

Approved by:



J. Anderson Plumer

For

Federal Aviation Administration
Technical Center
Atlantic City Int'l Airport, NJ 08405

Contract No. DTFA03-92-C-00003

LTI Project No. 1074

August 1993

Lightning Technologies, Inc.
10 Downing Parkway
Pittsfield, MA 01201
U.S.A.

1. Report No.		2. Government Accession No.		3. Recipient's Catalog No.	
4. Title and Subtitle Aircraft Fuel System Lightning Protection Design and Qualification Test Procedures Development: Standard Thermal Spark Ignition Source				5. Report Date August 1993 Revised 28 February 1994	
				6. Performing Organization Code	
7. Author(s) Keith E. Crouch				8. Performing Organization Report No. LT-93-970 Revision A	
9. Performing Organization Name and Address Lightning Technologies, Inc. 10 Downing Parkway Pittsfield, MA 01201				10. Work Unit No. (TRAIS) DTFA03-92-C-00003	
				11. Contract or Grant No.	
12. Sponsoring Agency Name and Address DOT/FAA FAA Technical Center Atlantic City Int'l Airport, NJ 08405				13. Type of Report and Period Covered Interim Report	
				14. Sponsoring Agency Code	
15. Supplementary Notes					
16. Abstract Fine metal wires interfacing with graphite surfaces and subjected to short duration current pulses is proposed as the most likely candidate for a standard thermal spark source. Descriptions of proposed procedures and apparatus for generating such thermal sparks are presented. Theoretical considerations leading to cautions in the process are also included.					
17. Key Words Lightning Qualification Fuels Design Testing			18. Distribution Statement		
19. Security Classif. (of this report) Unclassified		20. Security Classif. (of this page) Unclassified		21. No. of Pages 11	22. Price

AIRCRAFT FUEL SYSTEM LIGHTNING PROTECTION DESIGN
AND
QUALIFICATION TEST PROCEDURES DEVELOPMENT
STANDARD THERMAL SPARK
IGNITION SOURCE

ISSUE AND APPROVAL RECORD

Rev. Level	Report By	Date	Pages Revised or Added
A	K.E. Crouch	28 Feb. 1994	Incorporated results with pin-vise holders and discussed improvements needed for further development of the thermal spark ignition source. Added photographs and description of present equipment.

TABLE OF CONTENTS

SECTION	PAGE NO.
EXECUTIVE SUMMARY	iii
1.0 INTRODUCTION	1
2.0 THEORY OF OPERATION	1
3.0 OPERATING INSTRUCTIONS	3
4.0 PARTS LIST	10
4.1 Control Module	10
4.2 Source Module	10
5.0 REFERENCES	11

EXECUTIVE SUMMARY

The standard thermal spark ignition source will be used to verify and calibrate the ignition detection technique(s) before the technique(s) is used during fuel system lightning design and/or qualification testing. The source will produce thermal sparks at levels below, at, or above that needed to ignite 1.2 stoichiometric propane/air mixtures (representative of the threat in aircraft fuel systems).

The thermal spark source work reported here indicates that the approach under consideration, fine metal wires in contact with a graphite surface subjected to short duration current pulses, appears to hold the best promise of achieving the objective.

The proposed apparatus and procedures for further investigations toward the goal of an adjustable, repeatable source of thermal sparks is described. The probable theory of operation is discussed as well as potential problem areas that need further attention.

1.0 INTRODUCTION

Lightning strikes to aircraft may result in several conditions which can cause ignitions in the fuel system. These ignition hazards have been divided into three categories:

1. Voltage Sparks
2. Hot Spots
3. Thermal Sparks

This document describes a concept which can be used to develop a fixture which will provide a standard thermal spark ignition source (STISIS). The fixture would be designed so that the intensity of the source can be varied to operate at levels corresponding to a very high or a very low probability of igniting a fuel/air mixture.

When lightning tests are conducted on fuel system components, the response must be monitored to ensure that no ignition hazards exist. The ignition detection techniques used to monitor the tests must be calibrated to verify that they will detect an ignition hazard. Further, the detection technique must be capable of determining if the ignition source detected is below, at, or well above the criterion established for pass/fail on this particular component.

The STISIS fixture will be designed for installation in a lightning test area to verify the ignition detection technique to be used for that test series. The fixture is semi-portable and can be operated from 120 Vac. The fixture consists of the source module containing the contact materials and holders; and the control module housing the power supply, current source, switch, and pulse generator.

2.0 THEORY OF OPERATION

Tests and analysis carried out by Homan and Sirignano (Ref. 1), and others (Refs. 2 and 3) has shown that a stationary, burning particle of 20 microns (10^{-6} m) will ignite a propane/air mixture. The burning particle heats a small volume of air adjacent to the particle to some high temperature. This temperature level may be above that required for oxidation to take place so the fuel is instantaneously burned. The heat stored in this volume, along with heat supplied by the burning particle, spreads to surrounding volumes radially. This cools the initial volume and raises the temperature of the surrounding volumes causing them to burn. At some point, the temperatures and volumes reach a critical product such that the energy released by the burning (chemical reaction) of fuel and air heats the adjacent volume to the temperature at which the process becomes self propagating. A flame front is established which moves through the rest of the fuel/air volume burning all of the fuel.

The purpose of the thermal spark source is to produce burning particles in a repeatable, controlled manner. Several investigations have been conducted (Refs. 4 and 5) and the best candidate system appears to consist of an end-to-end contact

between a thin metal wire and a graphite rod. Currents passed through the contact heat the graphite which melts the wire. The duration and magnitude of the current pulse is selected to generate enough vaporization of the wire and plasma to ignite the molten particles and propel them out of the fixture into the fuel/air mixture surrounding the holder.

A small pin vise was used to hold the graphite rod. The graphite rod was made by grinding down a 5/32-inch diameter Air Carbon Arc Electrode. The diameter of the graphite rod used here (0.040 inches) was selected to fit the pin vises available. After the graphite rod was mounted securely in the pin vise, the vise was held perpendicular so that the surface of the graphite could be wiped clean and flat on a sheet of paper or very fine sand paper. The surface of the graphite rod was inspected using a 5-power magnifying glass.

Although no satisfactory means of holding the fine wires was developed during this effort, it is presumed that an approach which uses technology similar to that used in fine lead mechanical pencils could be adapted to the problem. A length of the wire would be stored in the holder/collet and fed out to interface with the graphite rod. This type of system would allow the burnishment of the wire end to make it flat and smooth.

Once the wire and rod are held firmly in the fixture, they can be positioned with a micrometer movement until they touch. Conformation of the contact pressure by measuring the contact resistance appears to be possible.

Using different current durations and amplitudes, values can be determined which will result in various probabilities of ignition. In general, larger burning particles are produced by using larger wires and/or longer current durations. It is somewhat obvious that if a larger wire is melted, larger particles will be generated. However, if a longer duration current pulse is applied to a wire of the same diameter, more energy will be available which will melt a longer section of that wire. Surface tension will tend to cause larger volumes to form into larger particles.

If an arc (plasma) were to be created between the end of the melted wire and the graphite rod, that plasma (at some level) could be responsible for igniting the fuel. Two considerations are involved in reducing the probability of such an occurrence. First, mechanical motions (movement of the melted material) take time usually in the millisecond region. If the current pulse has a duration of only a few microseconds, then there should always be a material path (metal) for the current to pass through.

Second, if an arc were to form, the gap involved would be very small, on the order of a few thousandths of an inch. Previous work (Ref. 6) has shown that the energy required to ignite a fuel/air mixture with such a small gap is on the order of a joule (0.35 to 1.5 joules). The energy supplied by the system in this type of testing will be less than 0.1 joules.

3.0 OPERATING INSTRUCTIONS

The objective is to establish a set of conditions which can be repeated and produce thermal sparks which will consistently ignite a propane/air mixture. It will take many tries at a test condition to establish the ignition probability. But hopefully, subsequent tests at the same conditions will result in the same ignition probability.

The apparatus used in this effort is shown schematically in Figure 1 and photographically in Figures 2 and 3. The current pulse was delivered from a 1000 V, 450 μ F capacitor bank. The actual size of the bank needed depends on the current level and duration of the pulse. The one used here allowed for pulses of up to 50 A for durations of up to 1 ms with less than a 10% change in amplitude. The final durations are expected to be far less, as are the amplitudes.

The current pulse was switched with a IGBT power module which was controlled by an optically isolated driver and gated with a pulse generator. The current level was controlled by a source resistor and the capacitor charge voltage.

The important parameters to control appear to be wire material, size, and end geometry; graphite composition (100% carbon) and end geometry; current pulse amplitude and duration; and possibly the contact pressure.

In the experiments conducted during this effort, the wires were cut using a razor blade which resulted in a slightly sloped surface. The end was inspected under a 100-power microscope and if the cut was more than slightly sloped, the wire was recut. The graphite rod surface was wiped on a paper to clean it between each test. No method monitoring the force applied to the interface was investigated. It was noted that when contact resistance measurement values of less than 10 ohms were observed, the contact interface behaved much more repeatably than when values greater than 50 ohms were observed. With more experience, it is hoped that monitoring the contact resistance as the two parts touch will be sufficient to confirm the contact at the interface.

Typical voltage and current oscillograms of a test are shown in Figure 4. This particular test used a slightly sloping wire end surface, but it also had a small burr on the final cut edge of the wire. When the wire contacted the graphite surface, the burr probably crushed, but it is doubtful that the aluminum deformed sufficiently to result in complete contact of the end of the wire with the graphite rod. Consequently, part way through the pulse (2.5 μ s) the portion of the aluminum wire in contact with the graphite melted. At this time only molten aluminum was available to carry the remainder of the current, and the voltage across the interface increased. At the end of the current pulse, the current drops, the molten plasma cools, and the voltage rises even further. During and following this period of time, the plasma vapor pressure expels burning particles out of the gap.

Had the full surface of the wire been in contact with the graphite, the energy deposited would not have melted the wire. Other tests conducted at this level did not

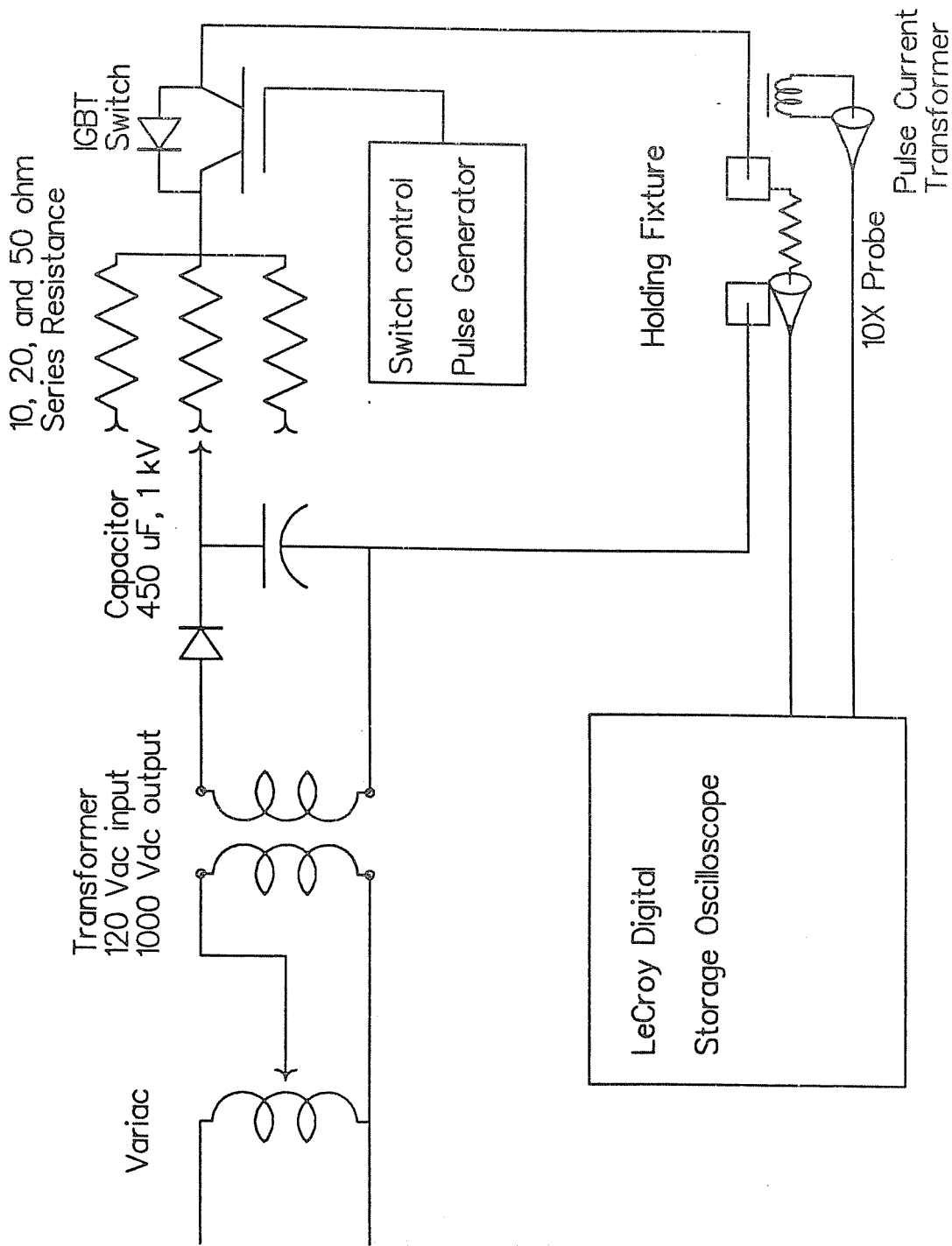
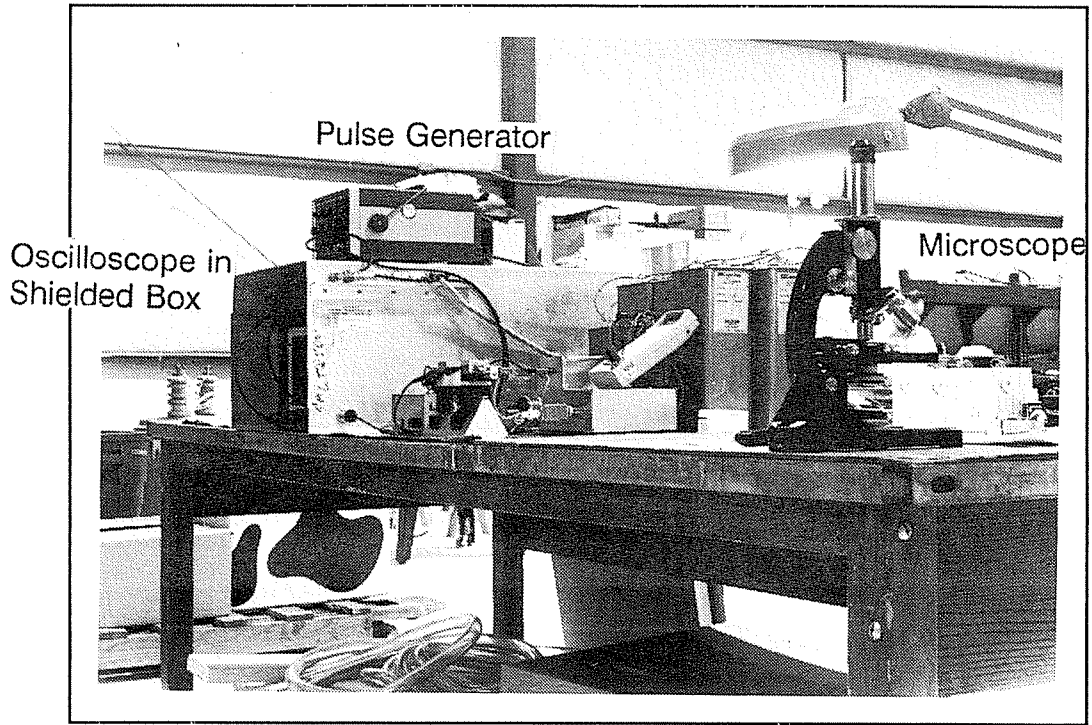
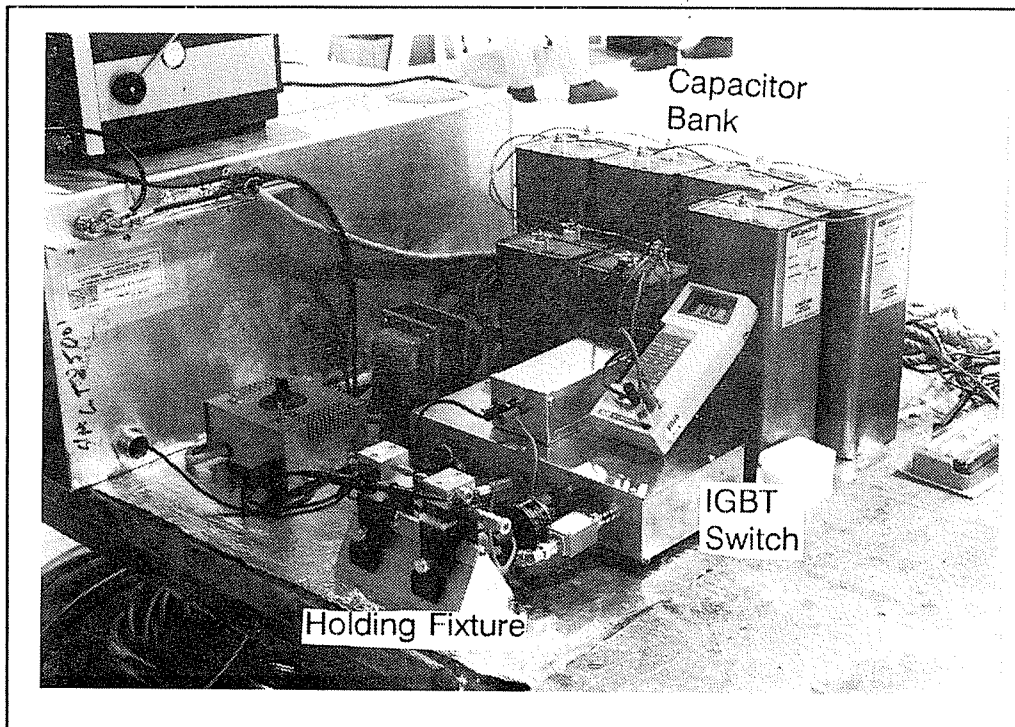

Figure 1 - STSIS Test Circuit Schematic Diagram



Entire Bench Setup



Generator and Fixture

Figure 2 - STSIS Test Configuration

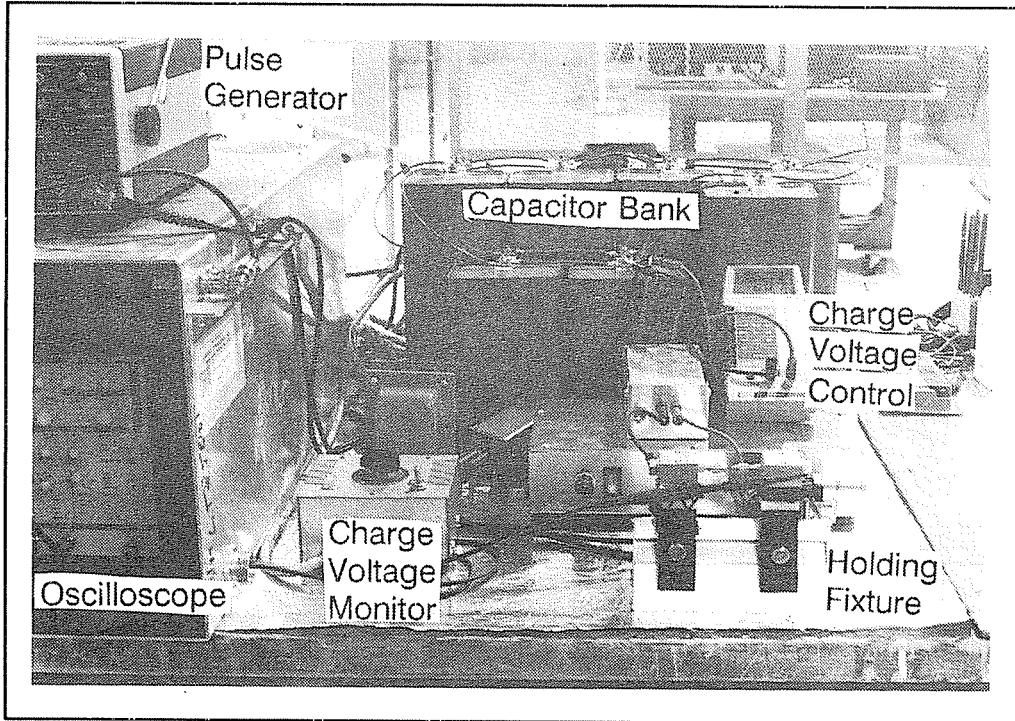

Position of Holder on Bench

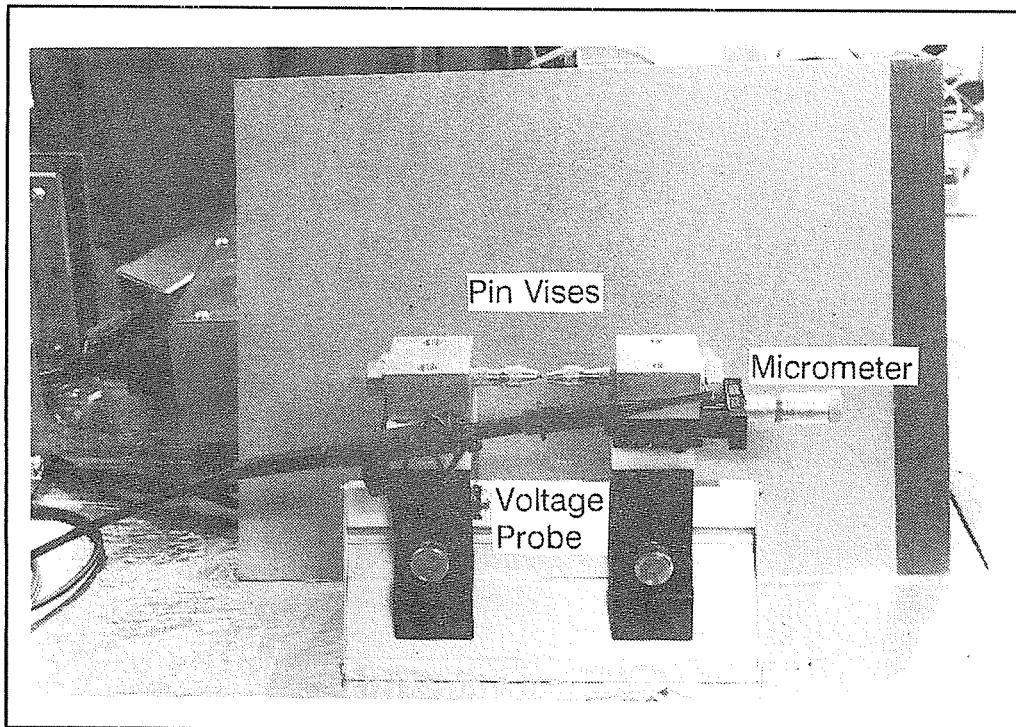

Close-up of Holding Fixture

Figure 3 - STSIS Holding Fixture

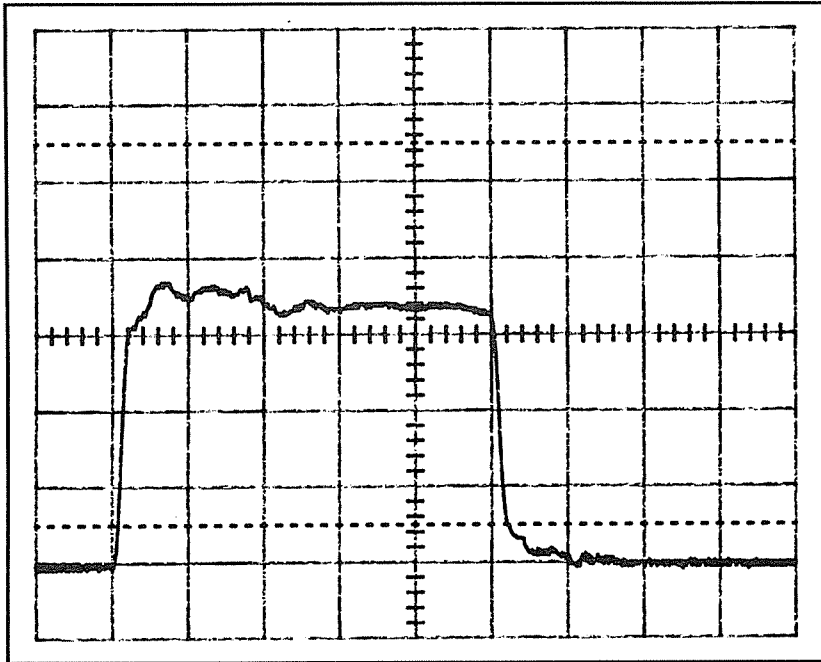

Current
 4 A/div.
 1 μ s/div.
 14 Ap

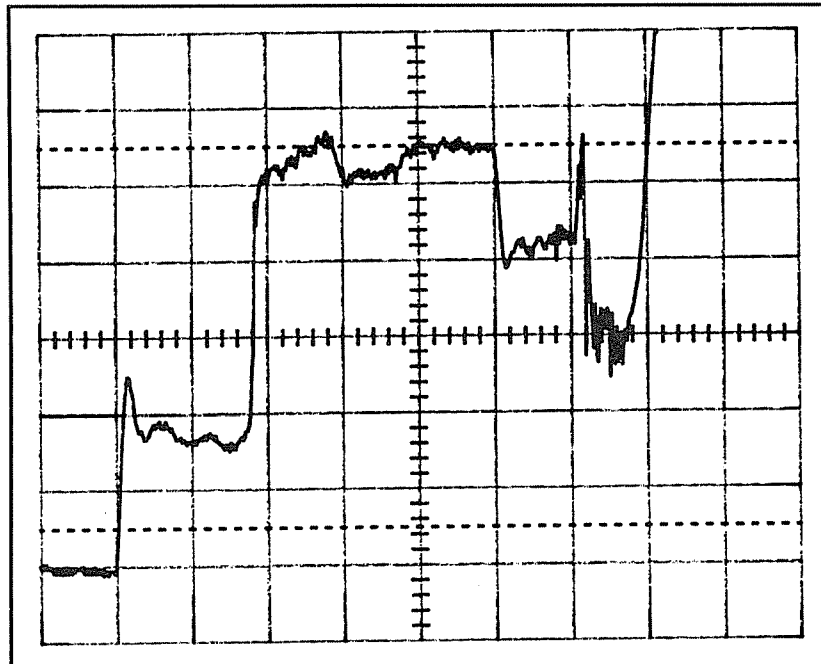

Voltage
 5 V/div.
 1 μ s/div.
 28 Vp

Figure 4 - Typical Voltage and Current Oscillograms of a Test Resulting in a Spark

result in melting or thermal spark formation. The energy delivered to the interface during these tests was about 700 μJ . Earlier calculations of the energy necessary to melt the end of the aluminum wire were about an order of magnitude higher. This would lead us to believe that only a small section of the wire actually melted. Microscopic inspection of the end of the wire after the test confirmed this premise as melting was only evident on part of the wire end surface. Typical voltage and current oscillograms of an earlier test without sparking is shown in Figure 5. Here no melting occurred, and at the end of the current pulse, the voltage returns to zero.

These tests confirmed that the mechanical controls used would not allow control of the fixture to a level which could repeat the performance within an order of magnitude.

Two aspects of the system were identified where greater precision is needed. First, as mentioned earlier in this report, a means of handling the wires must be developed. For the present effort, the wires were cut and handled by hand. Wires measuring 0.001, 0.003, and 0.005 inches in diameter of stainless steel and aluminum were cut approximately 0.75 inches long. Attempting to handle them with tweezers resulted in bending and slicing the wires. The wires had to be picked up, placed on a microscope slide, observed, and inserted into the pin vise by hand. It was very difficult to properly position the wires and they were often bent in handling. When this happened, the wires were straightened by rolling them under a flat metal ruler on the microscope slide glass. After installing the wires in the pin vise, they often had to be positioned by bending them to line up with the other pin vise holding the graphite rod. The bends had to be made in a manner which attempted to maintain a flat contact with the graphite. When this was not possible, the wire had to be removed and the process started over. It normally took over an hour to install and position a wire in the fixture.

A system similar to that used to position the lead in a fine mechanical pencil would appear to be an appropriate starting point for developing a holder for the wires. One system would have to be designed for each size of wire that is used. A length of wire would be inserted into the collet and moved through a small point guide as issued in the pencil. The point guide should probably be non-conductive and the current be applied through the collet. Since all parts of the system will be immersed in the fuel during tests, non-flammable materials must be used in the construction.

The second problem noted during these tests appeared to be associated with contact spring-back. The micrometer movement was used to position the wire against the graphite. However, when contact was made, a very, very slight motion of the wire would result in loss of contact. If the wire was pushed too far into the graphite, it would bend. Again, a very slight rebound of the fixture would result in loss of contact. Essentially, the system as constructed had no elasticity. When the micrometer was released, a very slight rebound would occur which resulted in loss of contact. The graphite rod holder should be spring-loaded so that when the wire touches it, it can move under a small force and maintain contact with the wire. The aluminum wire has a yield stress of about 25,000 pounds/inch². For a wire of 0.003-inch diameter, this

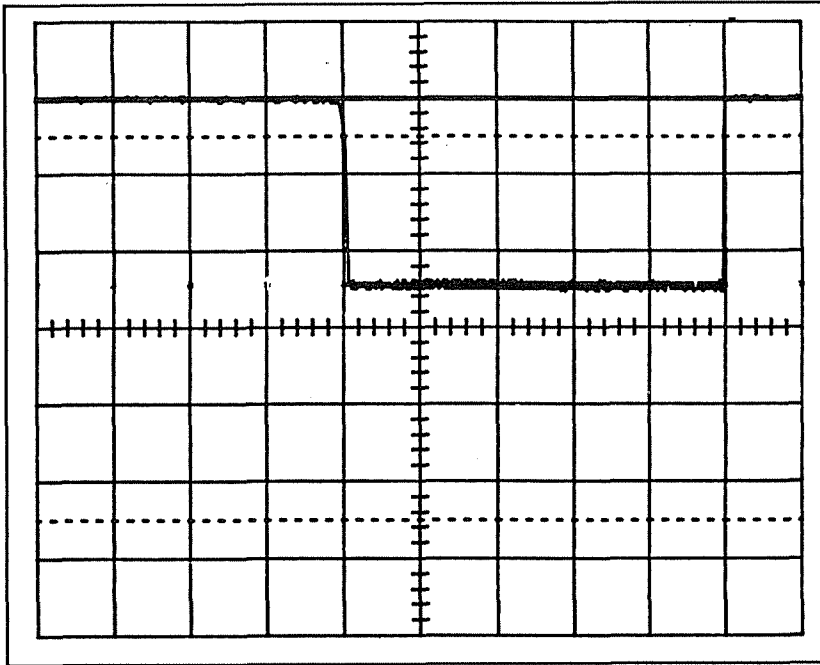

Current
 4 A/div.
 10 μ s/div.
 9.7 Ap

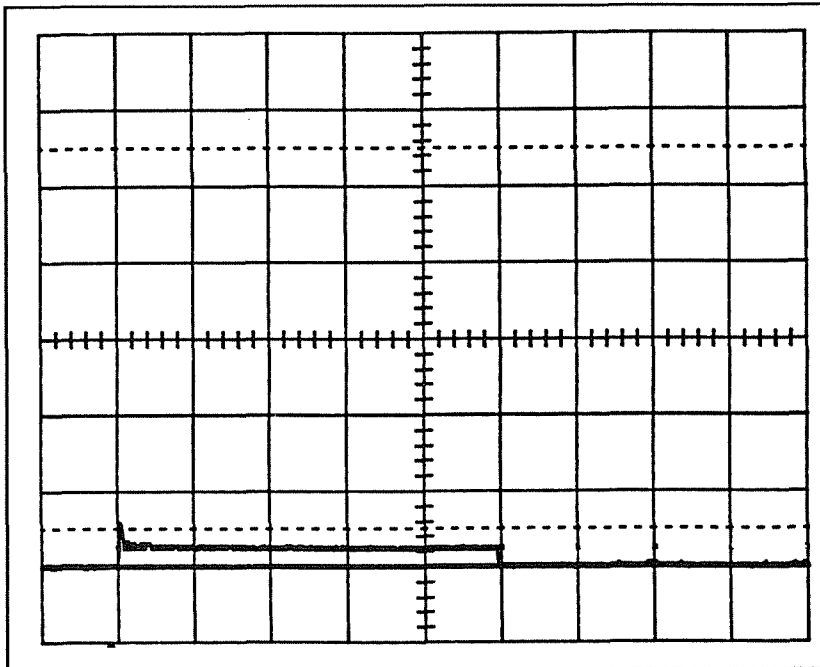

Voltage
 20 V/div.
 10 μ s/div.
 5 Vp

Figure 5 - Typical Voltage and Current Oscillograms of a Test Resulting in No Spark

translates into a capability of about 80 grams. If the fixture were spring-loaded such that the rod could move up to 0.3 mm before the force reached 80 grams, then the rebound problem could be avoided. To achieve this strength, the wire must be straight and probably extend no more than 1.5 mm beyond the end of the holder. A similar calculation can be made for the stainless steel and titanium wires.

4.0 PARTS LIST

The following components are suggested for exploring the continued development of an STSIS fixture. Sections of the system were assembled at Lightning Technologies, Inc. using these or similar components. Some of the components do have equivalent substitutes which should also perform satisfactorily.

4.1 Control Module

- 4.1.1 DC Power Supply 0-1000 V
- 4.1.2 Capacitor Bank 450 μ F maximum, 1500 V
- 4.1.3 Solid State Switch, Powerex Model IS621230 with M57958L control Module
- 4.1.4 Philips PM5715 Pulse Generator
- 4.1.5 LeCroy 9310 Digital Storage Oscilloscope
- 4.1.6 Pearson Model 411 Pulse Current Transformer
- 4.1.7 10X Voltage Probe
- 4.1.8 Inspection Microscope, 25X-300X
- 4.1.9 VOM, Fluke Model 8060A
- 4.1.10 Magnifier, Inspection, 5X
- 4.1.11 Series Resistor Box, 10, 20, and 50 ohms

4.2 Source Module

- 4.2.1 Mounting Plate
- 4.2.2 Pin Vise 0-1.4 mm
- 4.2.3 Holder, Wire, Custom Design
- 4.2.4 Micrometer Head, Nonrotating Spindle, Starrett #262RL
- 4.2.5 Graphite Rod, 0.040-in. dia., made from ARCAIR Air Carbon Arc Electrodes, 5/32-in. dia., Tweeco Products Inc., 4200 West Harry St., P.O. Box 12250, Wichita KS 67277 316-942-1421.
- 4.2.6 Fine Wires, Aluminum, Stainless Steel 304, & Titanium .001-, .003- and .005- inch dia., California Fine Wire Grover City, CA 93433

5.0 REFERENCES

1. Homan, H. and Sirignano, W., *Minimum Mass of Burning Aluminum Particles for Ignition of Methane/Air and Propane/Air Mixtures*, Eighteenth Symposium (International) on Combustion, pp. 1709-1717.
2. Law, C. K., *Ignition of a Combustible Mixture by a Hot Particle*, AIAA Journal, Volume 16, Number 6, June 1978, pp. 628-630.
3. Bowden, F. and Lewis, R., *Ignition of Firedamp by Stationary Metal Particles and Frictional Sparks*, Engineering, pgs. 186, 241 (1958).
4. Crouch, K., Status Report - *Thermal Spark Ignition Source*, Lightning Technologies, Inc. Report LT-93-948, April 1993.
5. Crouch, K., *Progress Report - Thermal Spark Ignition Source*, Lightning Technologies, Inc. Report LT-93-968, August 1993.
6. Crouch, K. E., *Development and Verification of a Standardized Spark Ignition Source*, Proceedings of the 1989 International Conference on Lightning and Static Electricity, Addendum pp. 8B.2.1-2.6, 26-28 Sept. 1989).

APPENDIX B

LT-92-854

**AIRCRAFT FUEL SYSTEM LIGHTNING
PROTECTION DESIGN AND
QUALIFICATION TEST PROCEDURES
DEVELOPMENT
STANDARD VOLTAGE SPARK
IGNITION SOURCE**

Prepared by:

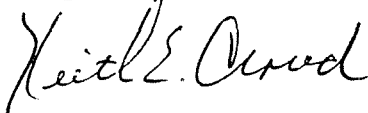

K. E. Crouch

Approved by:



J. Anderson Plumer

For

**Federal Aviation Administration
Technical Center
Atlantic City Int'l Airport, NJ 08405**

Contract No. DTFA03-92-C-00003

LTI Project No. 1074

October 1992

**Lightning Technologies, Inc.
10 Downing Parkway
Pittsfield, MA 01201
U.S.A.**

1. Report No.		2. Government Accession No.		3. Recipient's Catalog No.	
4. Title and Subtitle Aircraft Fuel System Lightning Protection Design and Qualification Test Procedures Development: Standard Voltage Spark Ignition Source				5. Report Date October 1992 Revised 24 August 1993	
				6. Performing Organization Code	
7. Author(s) Keith E. Crouch				8. Performing Organization Report No. LT-92-854 Revision A	
9. Performing Organization Name and Address Lightning Technologies, Inc. 10 Downing Parkway Pittsfield, MA 01201				10. Work Unit No. (TRAIS) DTFA03-92-C-00003	
				11. Contract or Grant No.	
12. Sponsoring Agency Name and Address DOT/FAA FAA Technical Center Atlantic City Int'l Airport, NJ 08405				13. Type of Report and Period Covered Interim Report	
				14. Sponsoring Agency Code	
15. Supplementary Notes					
16. Abstract A description of parts and procedures for the construction and operation of a standard voltage spark ignition source is presented. The theory of operation and operating precautions are included to supply the information necessary to properly use the system.					
17. Key Words Lightning Qualification Fuels Design Testing			18. Distribution Statement		
19. Security Classif. (of this report) Unclassified		20. Security Classif. (of this page) Unclassified		21. No. of Pages 31	22. Price

AIRCRAFT FUEL SYSTEM LIGHTNING
PROTECTION DESIGN AND
QUALIFICATION TEST PROCEDURES
DEVELOPMENT
STANDARD VOLTAGE SPARK
IGNITION SOURCE
ISSUE AND APPROVAL RECORD

Rev	By	Date	Rev App by	Pages Rev or Added
A	K. E. Crouch	24 August 1993	<i>Ja Plena</i>	Revised pages 1, 2, 4, 8, 12, 13 and added text and drawings to pages 17 thru 20

TABLE OF CONTENTS

SECTION	PAGE NO.
EXECUTIVE SUMMARY	iii
1.0 INTRODUCTION	1
2.0 THEORY OF OPERATION	1
3.0 OPERATING INSTRUCTIONS	2
4.0 PARTS LIST	3
4.1 Control Module	3
4.2 Source Module	4
5.0 DRAWINGS, SCHEMATICS, AND PHOTOGRAPHS	7
6.0 REFERENCES	31

EXECUTIVE SUMMARY

The standard voltage spark ignition source will be used to verify and calibrate the ignition detection technique(s) before the technique(s) is used during fuel system lightning design and/or qualification testing. The source will produce voltage sparks at levels below, at, or above that needed to ignite 1.2 stoichiometric propane/air mixtures (representative of the threat in aircraft fuel systems).

A complete description of the parts, assembly, calibration, and operating procedures for constructing and operating an adjustable level voltage spark source is presented. The theory of operation is included to acquaint users with the necessary information to properly use the system.

1.0 INTRODUCTION

Lightning strikes to aircraft may result in several types of hazards which can cause ignitions in the fuel system. These ignition hazards have been divided into three categories:

1. Voltage Sparks
2. Hot Spots
3. Thermal Sparks

This document describes a fixture which will provide a standard voltage spark ignition source (SVSIS). The fixture is designed so that the intensity of the source can be varied to operate at levels corresponding to a very high or a very low probability of igniting a fuel/air mixture.

When lightning tests are conducted on fuel system components, the response must be monitored to ensure that no ignition hazards exist. The ignition detection techniques used to monitor the tests must be calibrated to verify that they will detect the ignition hazard. Further, the detection technique must be capable of determining if the ignition source detected is below, at, or well above the criterion established for pass/fail on this particular component.

The SVSIS fixture is designed to be installed in a lightning test area to verify the ignition detection technique to be used for that test series. The fixture is semi-portable and can be operated from 120 V ac. The source consists of the source module, which contains the isolation resistors, variable energy storage capacitor, spark gap, and corona point. The control module contains a variable 10 kV dc power supply, electrostatic voltmeter, 5 kV dc corona power supply, and a 12 V ac heater supply.

2.0 THEORY OF OPERATION

Extensive testing, carried out by several researchers including Lewis and Von Elbe, Barreto, and Crouch (Ref. 1, 2, and 3), has shown that a voltage spark between two 3.2 mm diameter electrodes, spaced 2.0 mm apart, immersed in the proper stoichiometric fuel/air mixture, results in ignitions at the lowest stored energy. The finding is partly based on the assumption that all of the potential energy stored in the system ($1/2 CV^2$) will be dissipated in the spark that spans the volume between the two electrodes. To insure that this assumption is valid, short heavy leads and solid connections must be used between the capacitor and the spark gap.

The spark heats a small volume of air between the electrodes to a very high temperature (1,000's of degrees celsius). This temperature level is well above that required for oxidation to take place so the fuel is instantaneously burned. The heat stored in this volume spreads to the surrounding volume radially. This cools the core and raises the temperature of the surrounding volume causing it to burn. At some point, the temperature

and volume reach a critical product such that the energy released by the burning (a chemical reaction) of fuel and air heats the surrounding volume to the temperature at which the process becomes self propagating. At this point a flame front is established which moves through the rest of the fuel/air volume burning all of the fuel.

The energy deposited in the gap is controlled by the gap capacitance and the breakdown voltage of the gap. In air, a 2 mm gap will spark at $7.95 \text{ kV} \pm 2\%$. At this voltage, about 6 pF of capacitance is required to store the 200 microjoules of energy needed to cause an ignition. As reported by Crouch (Ref. 4), at 200 microjoules the probability of an ignition is about 1 in 1000. To get a more probable ignition, higher energies are necessary. For this purpose, the SVSIS described here has a variable capacitance of about 5 to 35 pF.

It was also found that the breakdown voltage of the 2 mm gap in the fuel/air mixture ranged between 9 and 11 kV for a slowly rising dc voltage. This was attributed to a lack of dust and other containments in the mixture (which contribute free electrons) resulting in a long statistical delay time for the gap. A corona source was incorporated into the design to provide a ultraviolet source of free electrons in the gap region. This stabilized the system so that sparks could be produced at the 8 kV level.

3.0 OPERATING INSTRUCTIONS

When the system is initially fabricated and assembled, the gap stray capacitance will be a significant portion of the lowest test level. The assembled system must be measured using a high quality capacitance bridge to calibrate the energy test levels. Normally a table giving the capacitance as a function of turns of the variable capacitor will be required. This calibration will hold for most applications since the source module (which contains the gap, isolation resistors and variable capacitor) is physically fixed and contained inside a housing. Unless conductive (metallic) assemblies are positioned very close to the gap electrodes, the gap capacitance will not be affected. For some customers, it may be necessary to calibrate the system at the point of use.

Because of the extremely high isolation resistance used in this fixture, all of the components must be kept very clean and dry. To assist in drying the capacitor and insulators, the 12 V heater mounted on the capacitor enclosure should be turned on about one hour prior to beginning tests. In very humid environments, dry heated air may need to be introduced into the capacitor enclosure. The capacitor enclosure cover is mounted with washers between the cover and the enclosure to facilitate ventilation of the interior.

1. Install the source module in or on the test chamber in which the tests are to be conducted. Be sure it is within the space monitored by the detection technique to be calibrated.
2. Connect the leads from the control module to the appropriate terminals on the source module.

3. Select the spark energy level to be used and set the capacitance by adjusting the variable capacitor knob. Note that even though the capacitor is infinitely variable, values attainable in steps of ± 1 turn are normally adequate for most tests.
4. Polish the electrode tips with 800 grit emery cloth (or equivalent) maintaining the surface radius.
5. Clean the electrodes with solvent alcohol and cotton cloth, rinse and air dry.
6. Install electrodes in the fixture, adjust the gap to 2 mm (0.0787 inch, #47 drill), tighten lock nuts and verify gap. CAUTION: Do not contaminate electrodes tips during installation, wear clean gloves or finger cots.
7. Close chamber (as required), activate the detection technique system and verify readiness as necessary.
8. Clear area around source module of personnel

CAUTION: VOLTAGES USED ARE LETHAL

9. Turn on control module and set gap dc power supply to 8 kV (or level which will result in 8 kV). Monitor the electrostatic voltmeter. If the gap does not break down before or at 8 kV, turn on corona source voltage (5 kV).
10. Turn off gap dc power supply and record voltage at which gap broke down. Energy delivered to the spark was $1/2 CV^2$.
11. Verify detection technique response. If additional tests are required, repeat starting at step 3 as required.

4.0 PARTS LIST

The following parts are suggested for the SVSIS fixture. A prototype was assembled at Lightning Technologies, Inc. using these parts, and was found to operate satisfactorily. Some of the parts do have equivalent substitutes which will also operate satisfactorily, but only those parts listed here were verified.

4.1 Control Module

- 4.1.1 Cabinet, Rack, Bud Cat. No. CR-1739
- 4.1.2 DC Pwr. Supply, Hipotronics Model No. R10B
- 4.1.3 DC Pwr. Supply, Hipotronics Model No. R5B
- 4.1.4 Electrostatic V M, Sensitive Research Model No. ESH 2--

4.2 Source Module

- 4.2.1 Enclosure, Corona (Dwg)
- 4.2.2 Enclosure, Capacitor (Dwg)
- 4.2.3 Cover, Capacitor Englosure (Dwg)
- 4.2.4 Plate, Mounting (Dwg)
- 4.2.5 Bushing, Insulator (Dwg) (3-1, 3-2 Reqd.)
- 4.2.6 Sphere, Shield (Dwg) (9 Reqd.)
- 4.2.7 Nut, Teflon 214-10
- 4.2.8 Bushing, Conductor (Dwg) (6 Reqd.)
- 4.2.9 Standoff H H Smith Cat. No. NL-523W02-008 (6 Reqd.)
- 4.2.10 Coupling, Flex, H H Smith Cat. No. 164
- 4.2.11 Shaft bushing, H H Smith Cat. No. 119
- 4.2.12 Knob, H H Smith Cat. No. 2208
- 4.2.13 Shaft, Insulating (Dwg)
- 4.2.14 Capacitor, Variable, Jennings Cat. No. CADD-30-0115
- 4.2.15 Cap. Mount, Front (Dwg)
- 4.2.16 Cap. Mount, Rear (Dwg)
- 4.2.17 Mount, Electrode (Dwg)
- 4.2.18 Holder, Electrode (2 Reqd.) (Dwg)
- 4.2.19 Electrode (2 Reqd) (Dwg)
- 4.2.20 Mount, Corona Point (Dwg)
- 4.2.21 Holder, Corona Point (Dwg)
- 4.2.22 Corona Point H H Smith Cat. No. 128
- 4.2.23 Shield, Corona (Dwg)
- 4.2.24 Resistor, Charging IRC F44-TU-150G- $\pm 5\%$
- 4.2.25 Resistor, Isolation, IRC F44-TU-5G- $\pm 5\%$
- 4.2.26 Resistor, Corona, IRC F44-TU-50M- $\pm 5\%$
- 4.2.27 Heater Resistor Holder (Dwg) (2 Reqd.)
- 4.2.28 Binding Post, Superior Electric BP30WT (2 Reqd.)
- 4.2.29 Insulator Stand-off HH Smith 52-2001 (4 Reqd.)
- 4.2.30 Resistor Pwr, Radio Shack 50 ohms 10 W 271-133 (4 Reqd.)
- 4.2.31 Screw, Phil, Oval Hd, 8/32 x 3/4 SS (13 Reqd.)
- 4.2.32 Screw, Slted, Rnd Hd, 8/32 x 1/2 SS (3 Reqd.)
- 4.2.33 Screw, Phil, Pan Hd, 6/32 x 1/2 SS (12 Reqd.)
- 4.2.34 Screw, Phil, Pan Hd, 10/32 x 1/4 SS (6 Reqd.)
- 4.2.35 Screw, Phil, Pan Hd, 10/32 x 1/2 SS (2 Reqd.)
- 4.2.36 Nut, 1/4-32 H H Smith Cat. No. 1186C (2 Reqd.)
- 4.2.37 Nut, Jam, 1/4-28 Brass (4 Reqd.)
- 4.2.38 Nut, Hex, 8/32 SS
- 4.2.39 Nut, Hex, 10/32 SS (4 Reqd.)
- 4.2.40 Nut, Hex 6/32 Brass (24 Reqd.)
- 4.2.41 Washer, Flat, No. 6, SS (36 Reqd.)
- 4.2.42 Washer, Flat, No. 8, SS (3 Reqd.)
- 4.2.43 Washer, Flat, No. 10, SS (4 Reqd.)

- 4.2.44 Cable, Coaxial, RG 58 A/U (AR to connect control module and source module - terminate with appropriate crimp-on connectors)
- 4.2.45 Wire, AWG #16 (AR to connect components in the corona circuit - terminate with appropriate crimp-on connectors)
- 4.2.46 Wire, AWG #10 Solid (AR to connect components in the gap circuit - terminate with appropriate crimp-on connectors)

Manufacturers List

Bud	Bud Industries, Inc. 4605 East 355th St. P.O. Box 431 Willoughby, OH 44094 216-946-3200
Hipotronics	Hipotronics Route 22 P.O. Drawer A Brewster, NY 10509 914-279-8091
Sens. Res.	Electrical Instrument Service, Inc. 25 Dock Street Mount Vernon, NY 10550 914-699-9717
H H Smith	H H Smith, Inc. 812 Snediker Ave Brooklyn, NY 11207 212-272-9400
Jennings	International Telephone and Telegraph 970 McLaughlin Ave San Jose, CA 95122 408-292-4025
IRC	International Resistive Company, Inc. Greenway Road P.O. Box 1860 Boone, NC 28607 704-264-8861
Glastic	The Glastic Company 4321 Glenridge Road Cleveland, OH 44121 216-486-0100
Misc.	McMaster-Carr Supply P.O. Box 440 New Brunswick, NJ 08903 908-329-3200

5.0 DRAWINGS, SCHEMATICS, AND PHOTOGRAPHS

Drawings of parts which must be fabricated (or were fabricated at Lightning Technologies, Inc.) follow as well as circuit schematics and photographs of the assembled source.

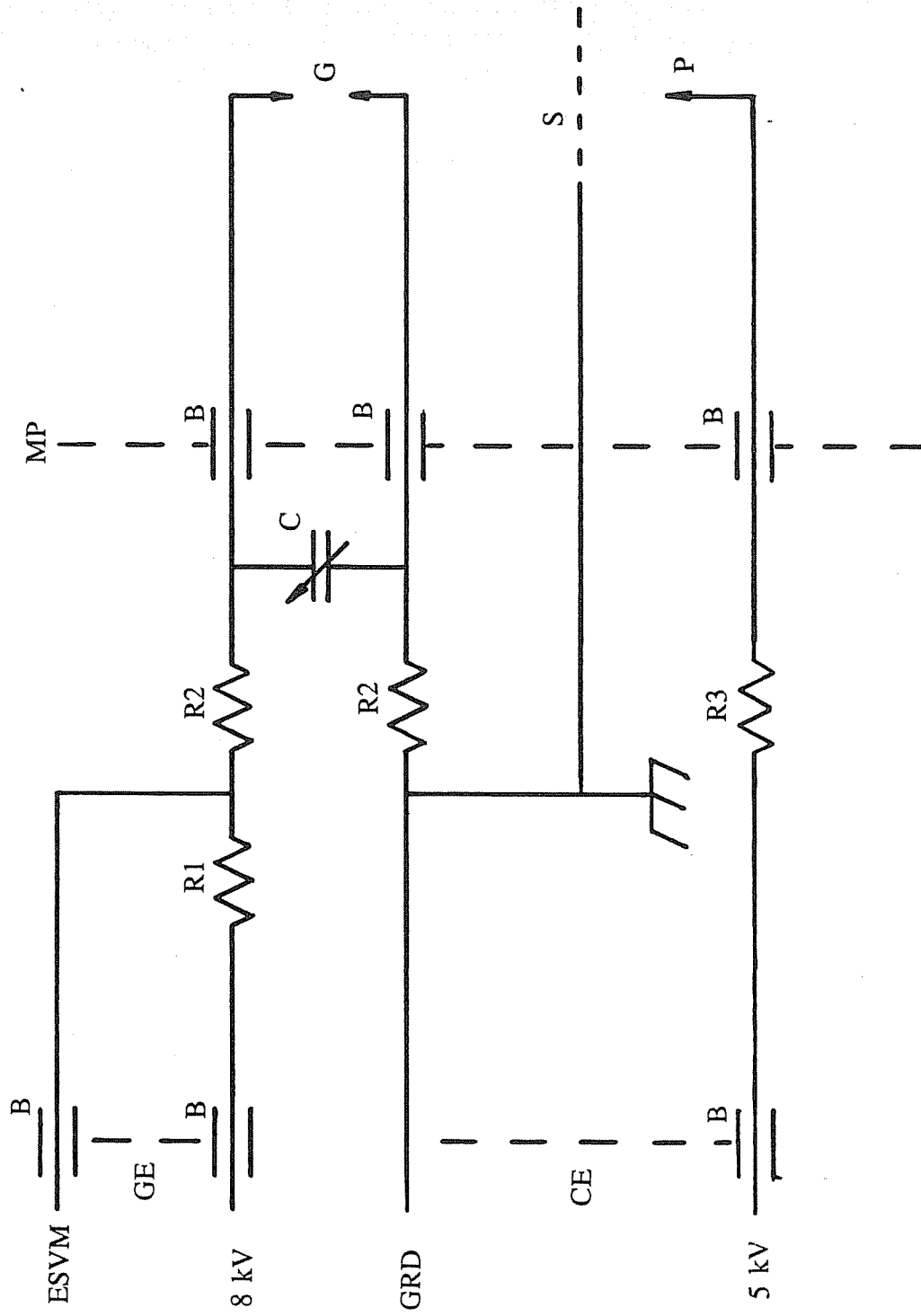

Schematic
Source Module

**SCHEMATIC DIAGRAM
SYMBOL LIST**

B	Bushing	4.2.4 - 4.2.8
C	Capacitor	4.2.14
CE	Corona Enclosure	4.2.1
ESVM	Electrostatic Voltmeter	4.1.4
G	Gap, 2 mm	
GE	Gap Enclosure	4.2.2
GRD	Ground	
MP	Mounting Plate	4.2.3
R1	Charging Resistor (150 G)	4.2.24
R2	Isolation Resistor (5G)	4.2.25
R3	Corona Resistor (50 M)	4.2.26
S	Corona Shield	4.2.23
5 kV	Corona Power Supply	4.1.3
8 kV	Gap Power Supply	4.1.2
P	Corona Point	4.2.22

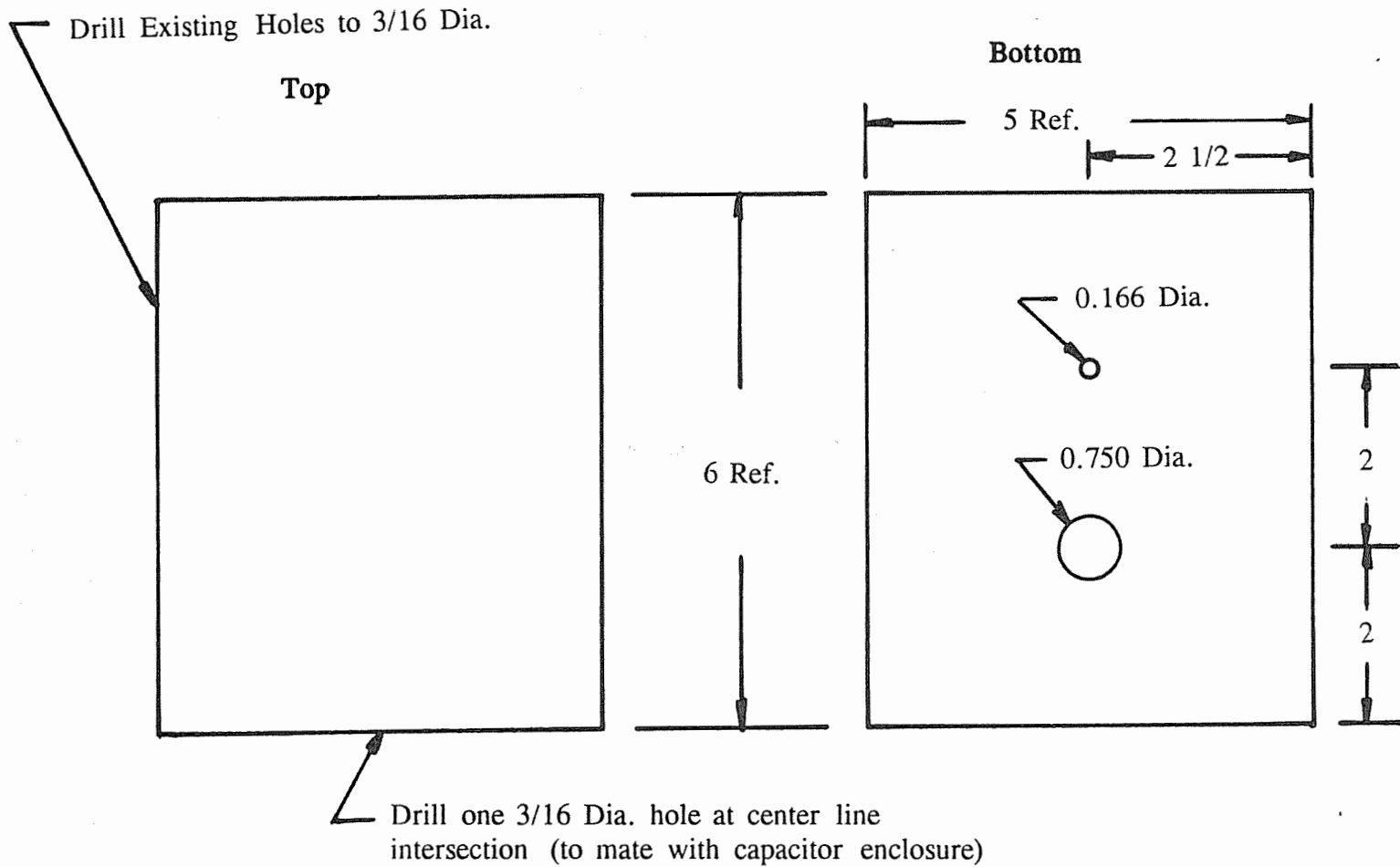

B-14
10

Material - Make from Bud AU 1040

Tolerance: XXX ± .005
 XX ± .010
 X ± .015
 X/X ± 1/32

Note: Features and locations may not all be to scale.

All dimensions are in inches.

Enclosure, Corona

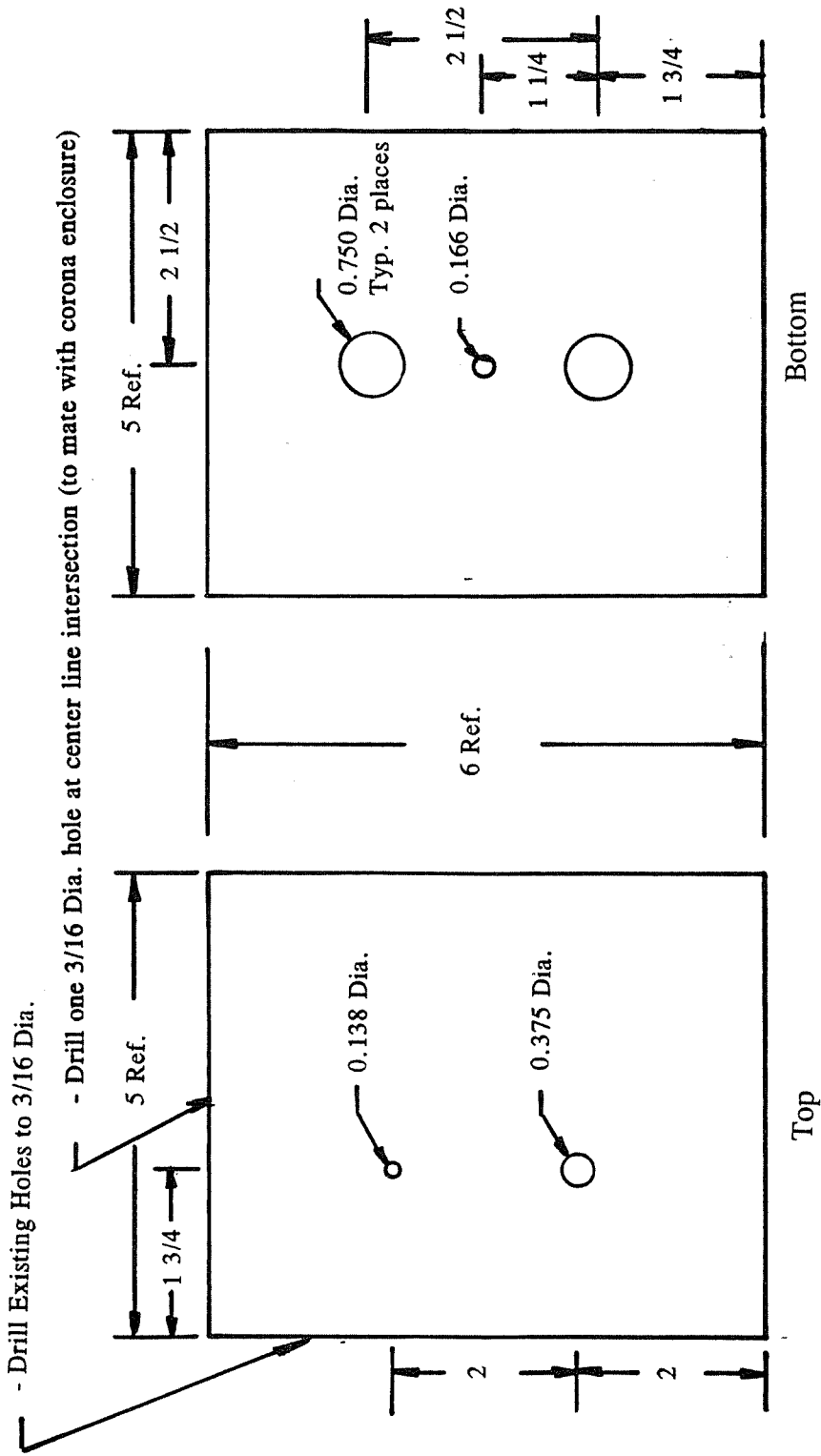

Material - Make from Bud AU 1040

Tolerance: XXX ± .005
 XX ± .010
 X ± .015
 X/X ± 1/32

Note: Features and locations may not all be to scale.
 All dimensions are in inches.

Enclosure, Capacitor

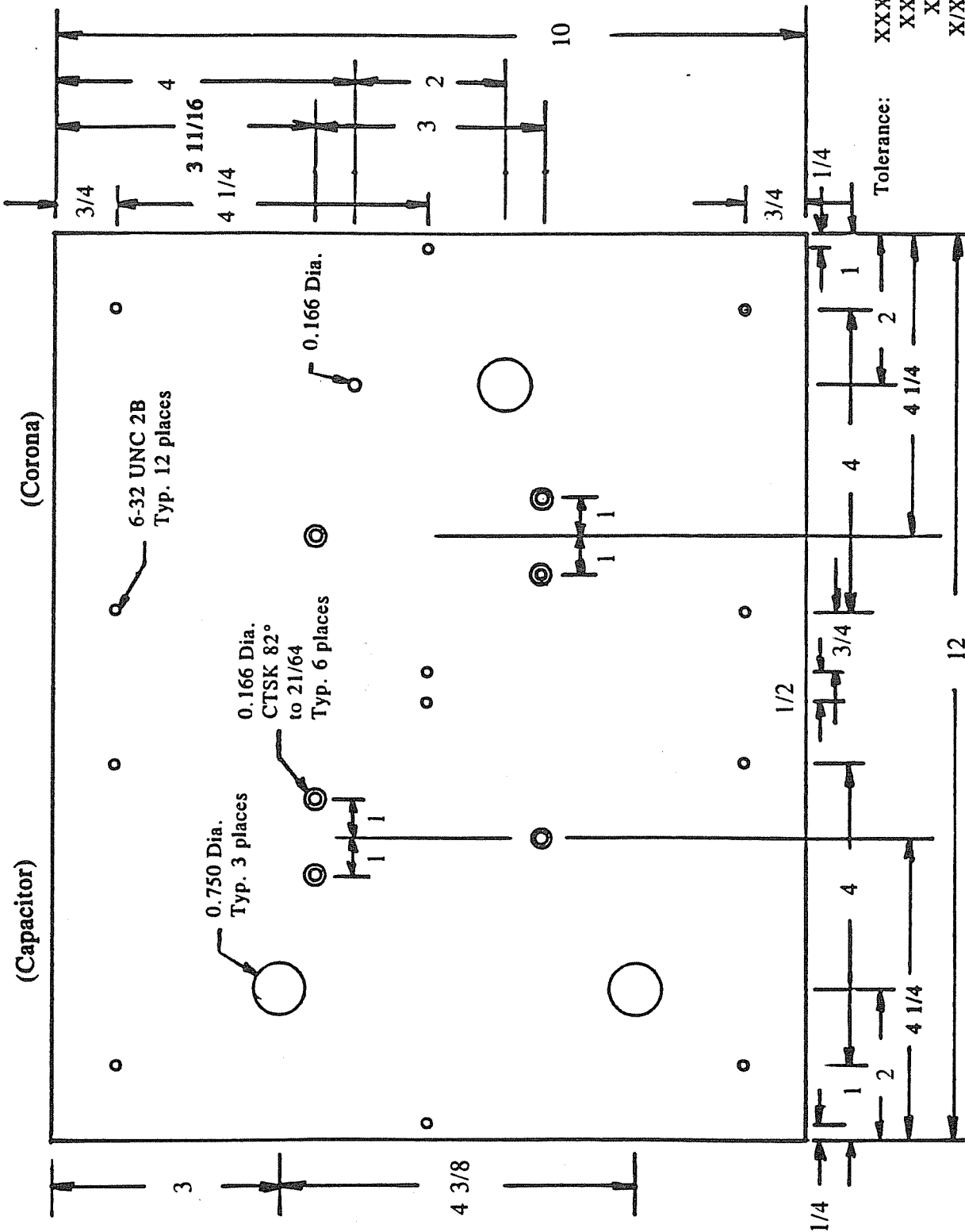

Material - 3/8 Yorolite, G11 Note: Features and locations may not all be to scale. All dimensions are in inches. Mounting Plate

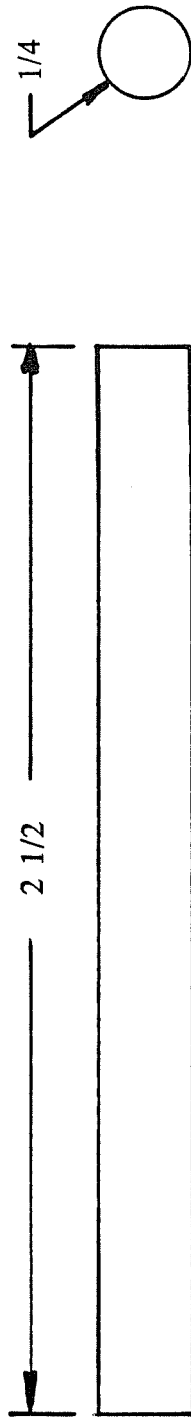

Material - Yorolite G11, 1/4 Rod

Tolerance: XXX $\pm .005$
 XX $\pm .010$
 X $\pm .015$
 X/X $\pm 1/32$

Note: Features and locations may not all be to scale.

All dimensions are in inches.

Shaft, Insulating

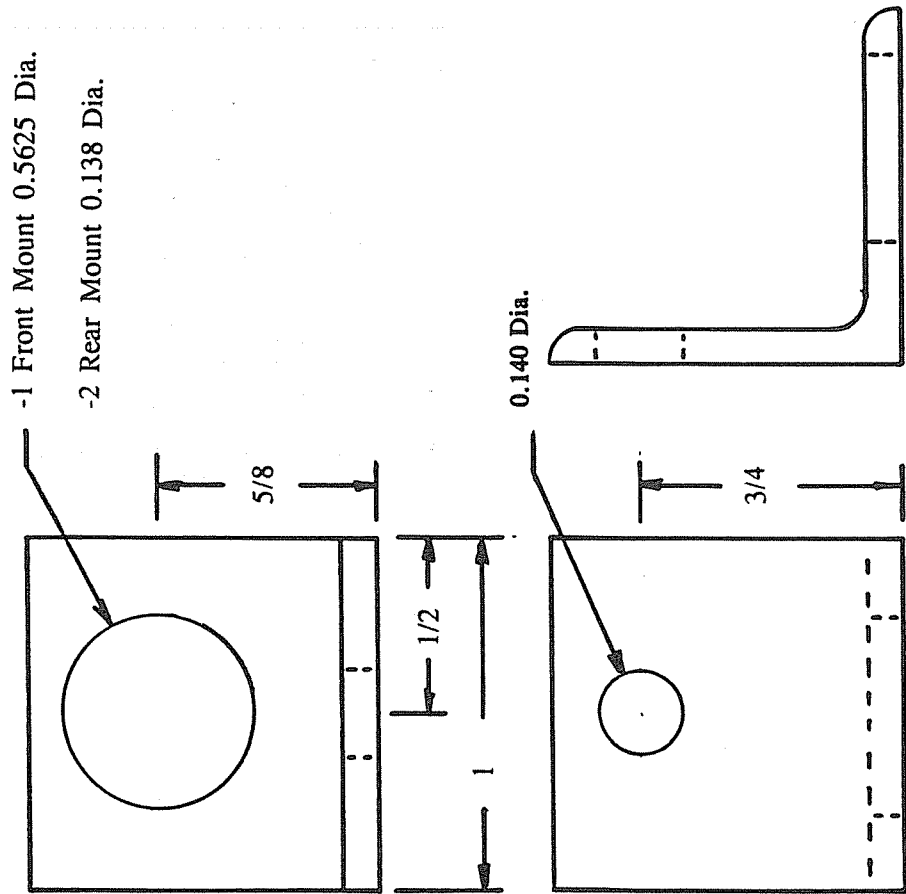

Mounts, Capacitor

Material - 1 x 1 x 1/8 Aluminum Angle

Tolerance: XXX ± .005
 XX ± .010
 X ± .015
 X/X ± 1/32

Note: Features and locations may not all be to scale.
 All dimensions are in inches.

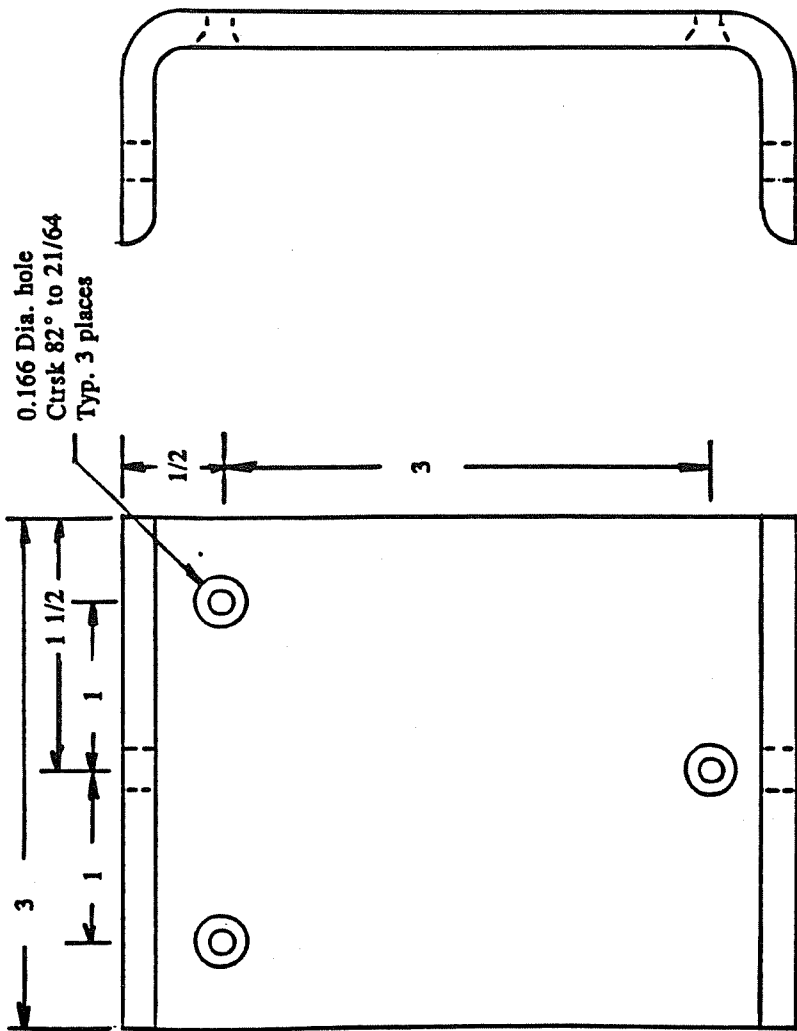

Note: Features and locations may not all be to scale.

All dimensions are in inches.

Tolerance: XXX ± .005
 XX ± .010
 X ± .015
 X/X ± 1/32

Mount, Electrode

Material - Fiberglass Channel
 Glastic 2242-3A

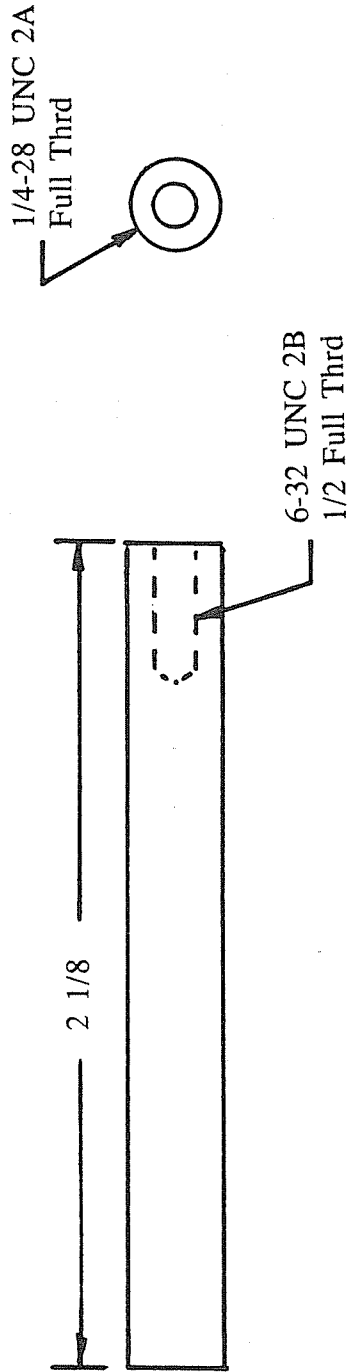

Material - 1/4 Brass Rod

Tolerance: XXX ± .005
 XX ± .010
 X ± .015
 X/X ± 1/32

Note: Features and locations may not all be to scale.

All dimensions are in inches.

Holder, Electrode

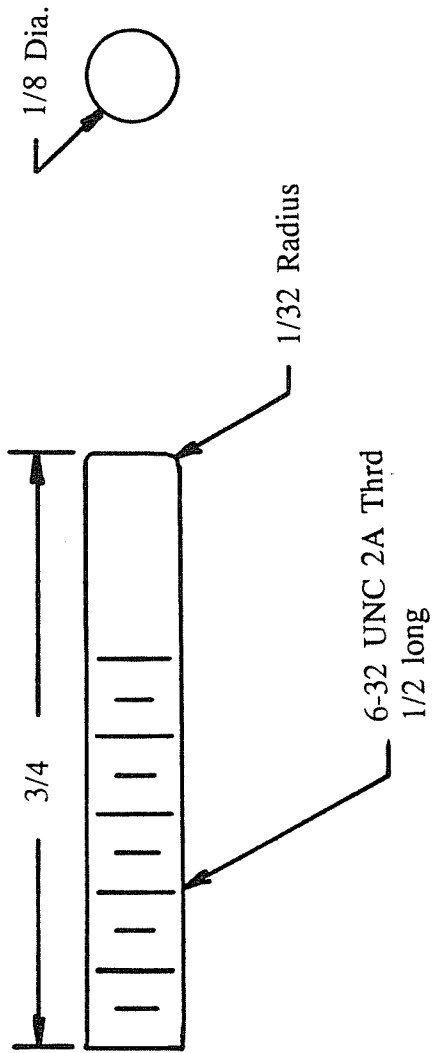

Material - 1/8 Aluminum Rod

Tolerance: XXX ± .005
 XX ± .010
 X ± .015
 X/X ± 1/32

Note: Features and locations may not all be to scale.
 All dimensions are in inches.

Electrode

0.166 Dia. hole
 Ctrsk 82° to 21/64
 Typ. 3 places

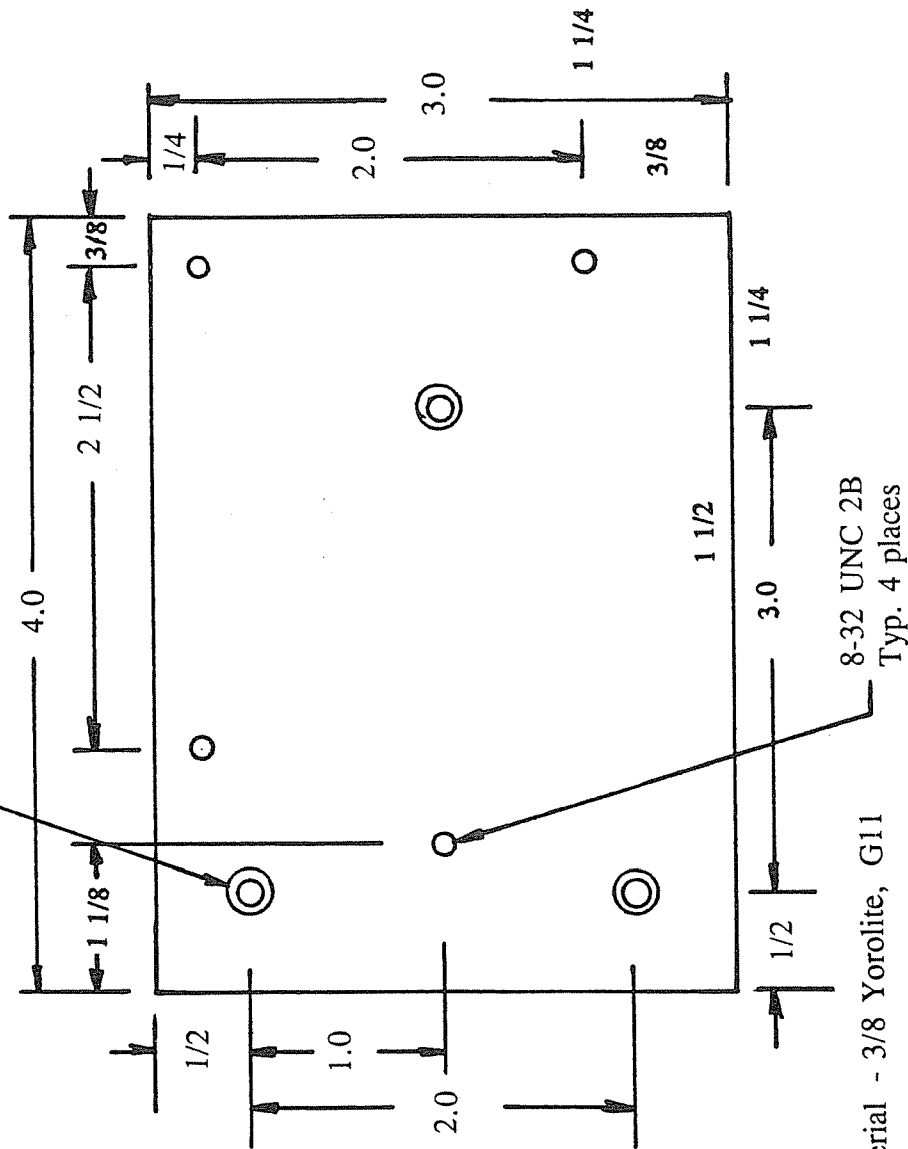

Mount, Corona Point

Material - 3/8 Yorolite, G11

Tolerance: XXX ± .005
 XX ± .010
 X ± .015
 X/X ± 1/32

Note: Features and locations may not all be to scale.
 All dimensions are in inches.

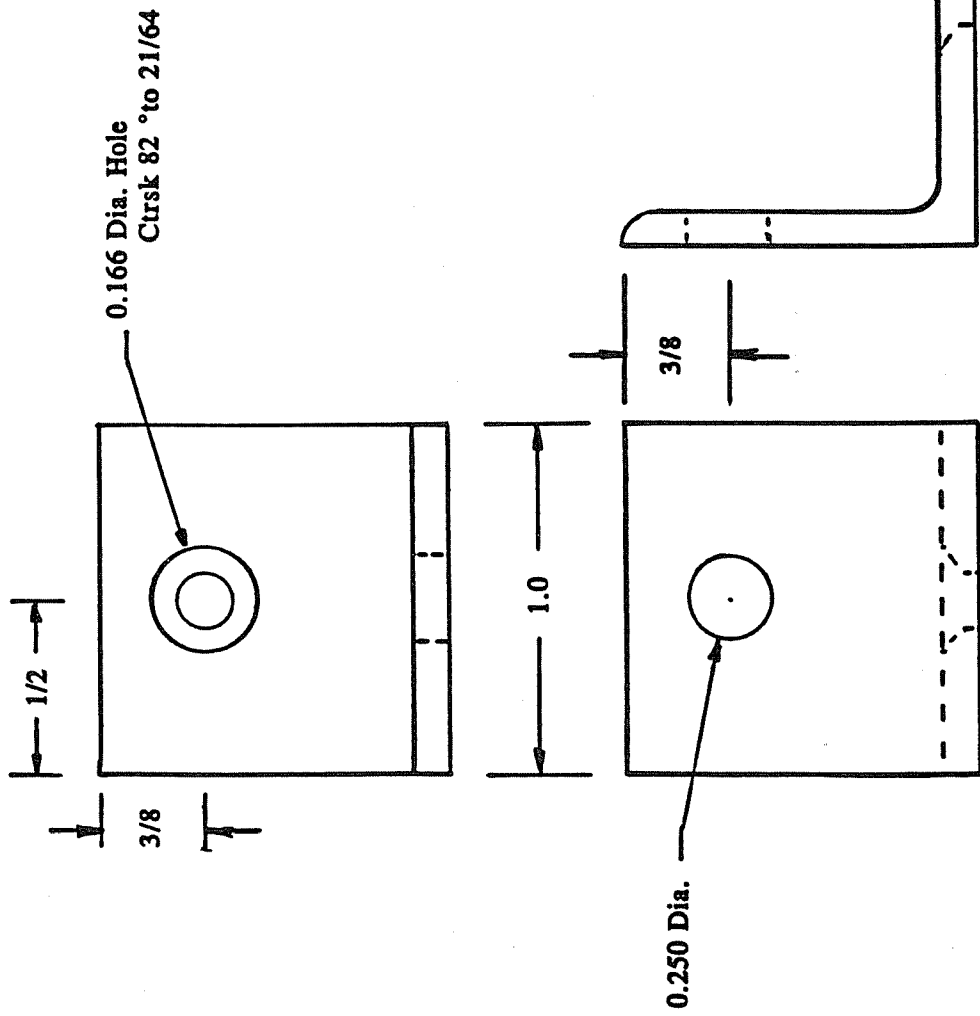

Holder, Corona Point

Material - 1 x 1 x 1/8 Fiberglass Angle

Tolerance: XXX ± .005 Note: Features and locations may not all be to scale.

XX ± .010

X ± .015

X/X ± 1/32

All dimensions are in inches.

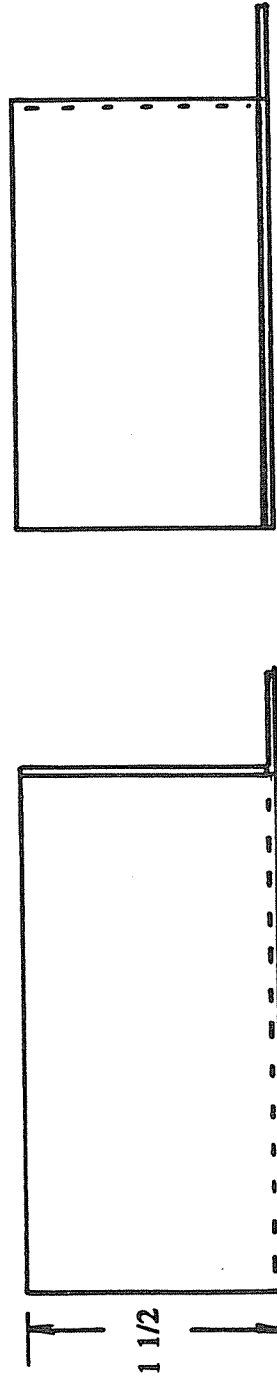
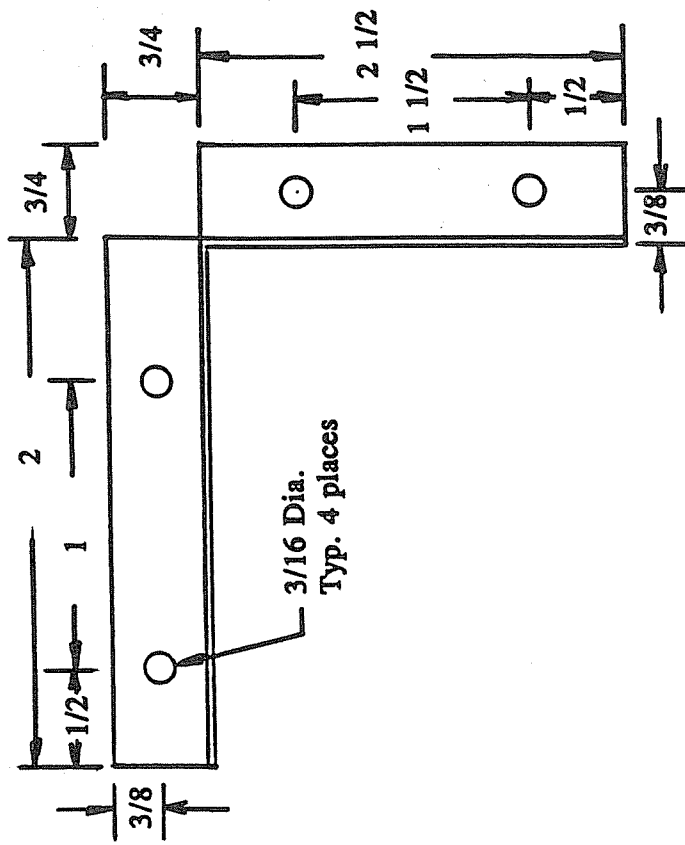

Material - Bronze Wire Cloth, 60 x 60 Mesh

Tolerance: XXX ± .005 Note: Features and locations may not all be to scale.

XX ± .010

X ± .015

X/X ± 1/32

All dimensions are in inches.

Shield, Corona

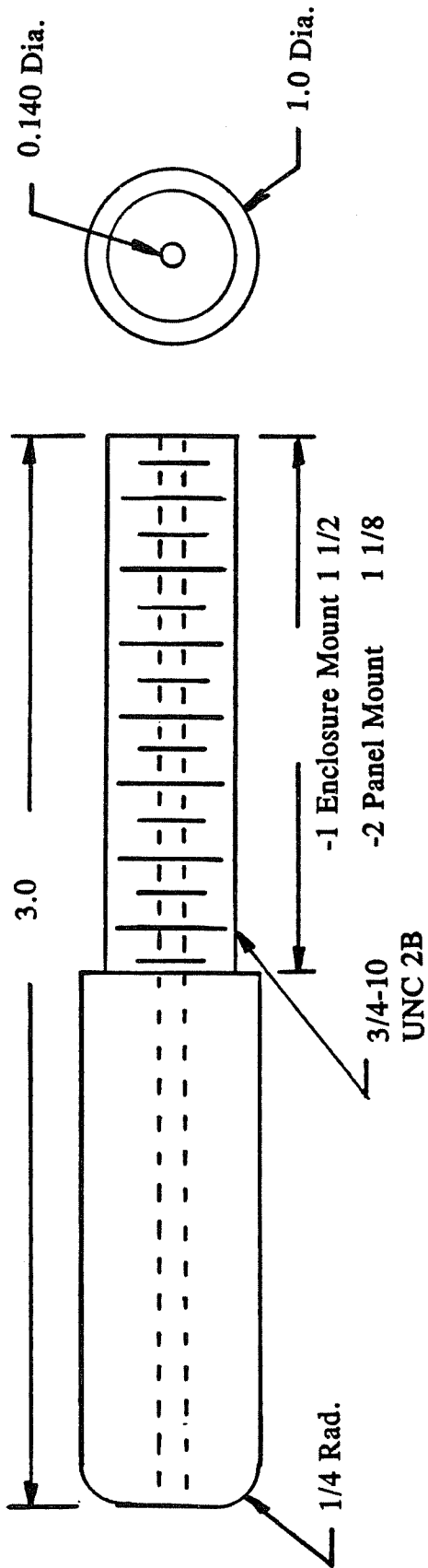

Material: Mech. Grade TFE
1" dia.

Tolerance: XXX ± .005 Note: Features and locations may not all be to scale.

XX ± .010

X ± .015

X/X ± 1/32

All dimensions are in inches.

Bushing, Insulator

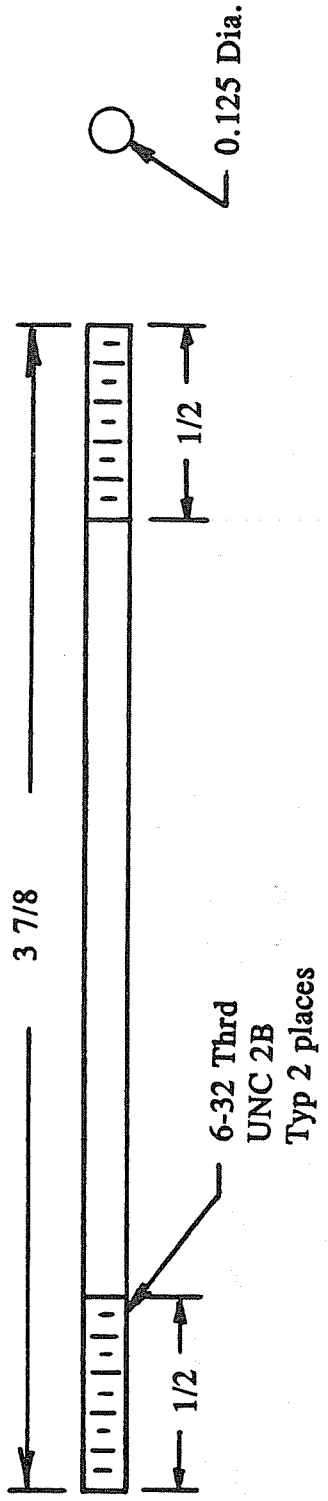

Material: 1/8 Brass Rod

Tolerance: XXX ± .005
 XX ± .010
 X ± .015
 X/X ± 1/32

Note: Features and locations may not all be to scale.
 All dimensions are in inches.

Conductor, Bushing

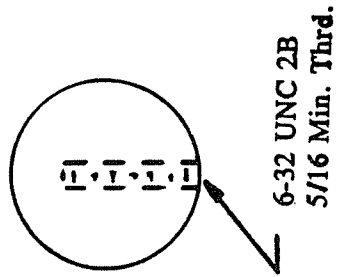

Material: 1/2 inch Brass Sphere

Tolerance: XXX ± .005
 XX ± .010
 X ± .015
 X/X ± 1/32

Sphere, Shield

Note: Features and locations may not all be to scale.

All dimensions are in inches.

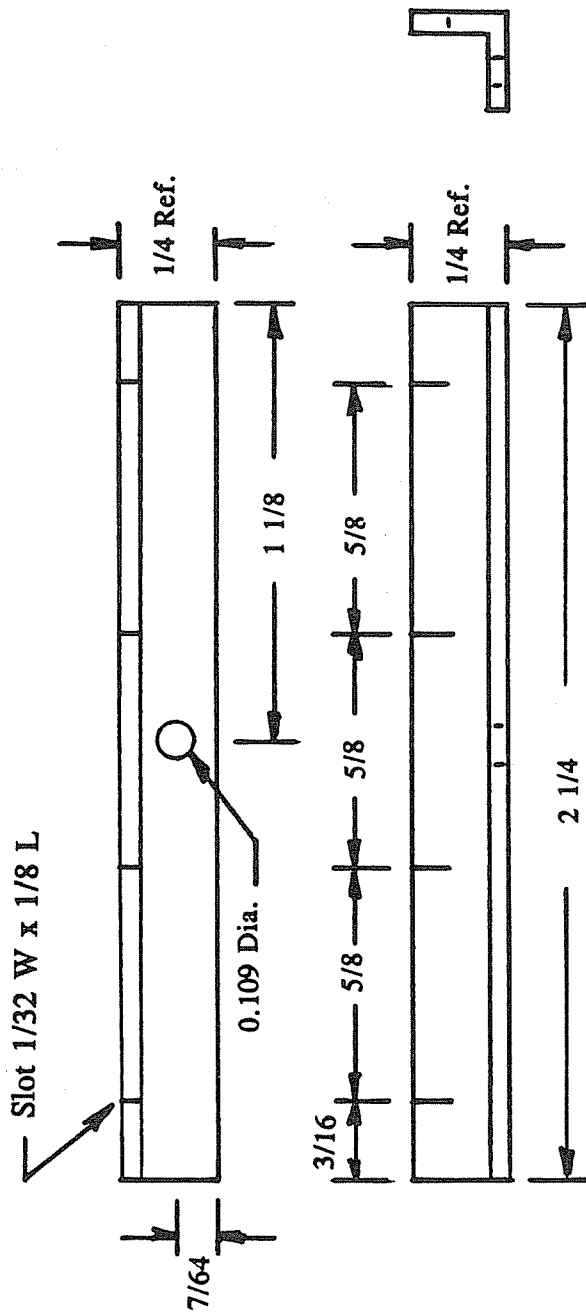

Material: $1/4 \times 1/4 \times 1/32$ Brass Angle

Tolerance: XXX $\pm .005$
 XX $\pm .010$
 X $\pm .015$
 X/X $\pm 1/32$

Holder, Heater Resistors

Note: Features and locations may not all be to scale.

All dimensions are in inches.

**Cover, Capacitor
Enclosure**

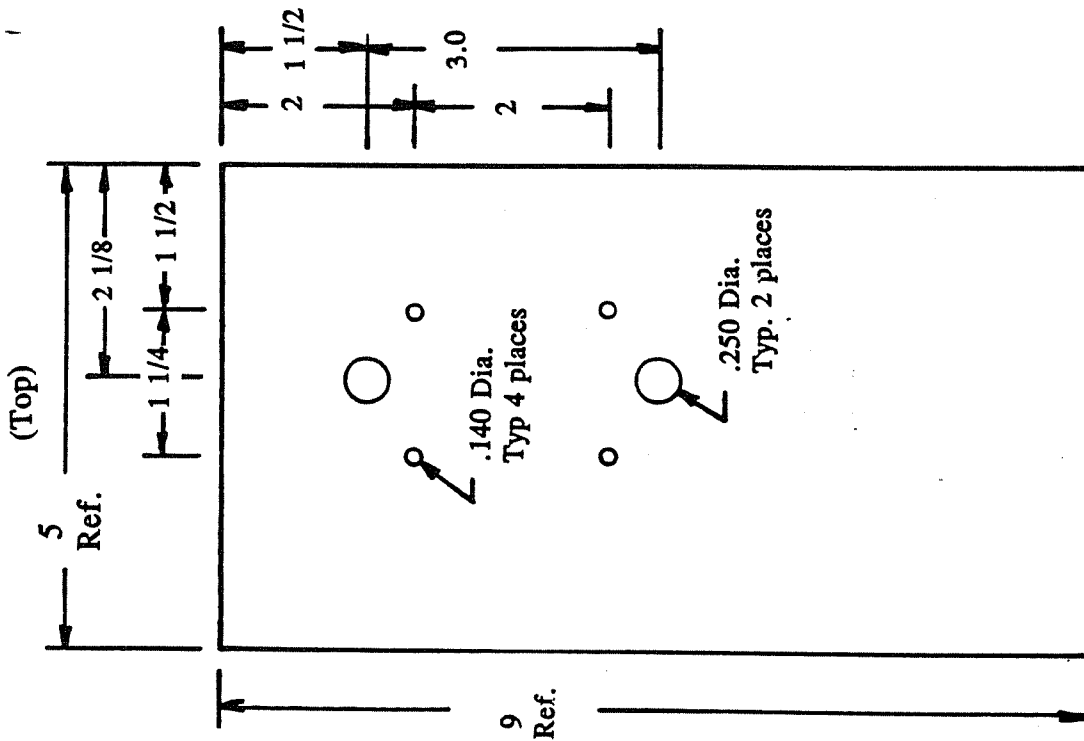

**Material: Enclosure
Cover (Supplied with Box)**

Tolerance: XXX ± .005
 XX ± .010
 X ± .015
 X/X ± 1/32

**Note: Features and locations
may not all be to scale.**

All dimensions in inches.

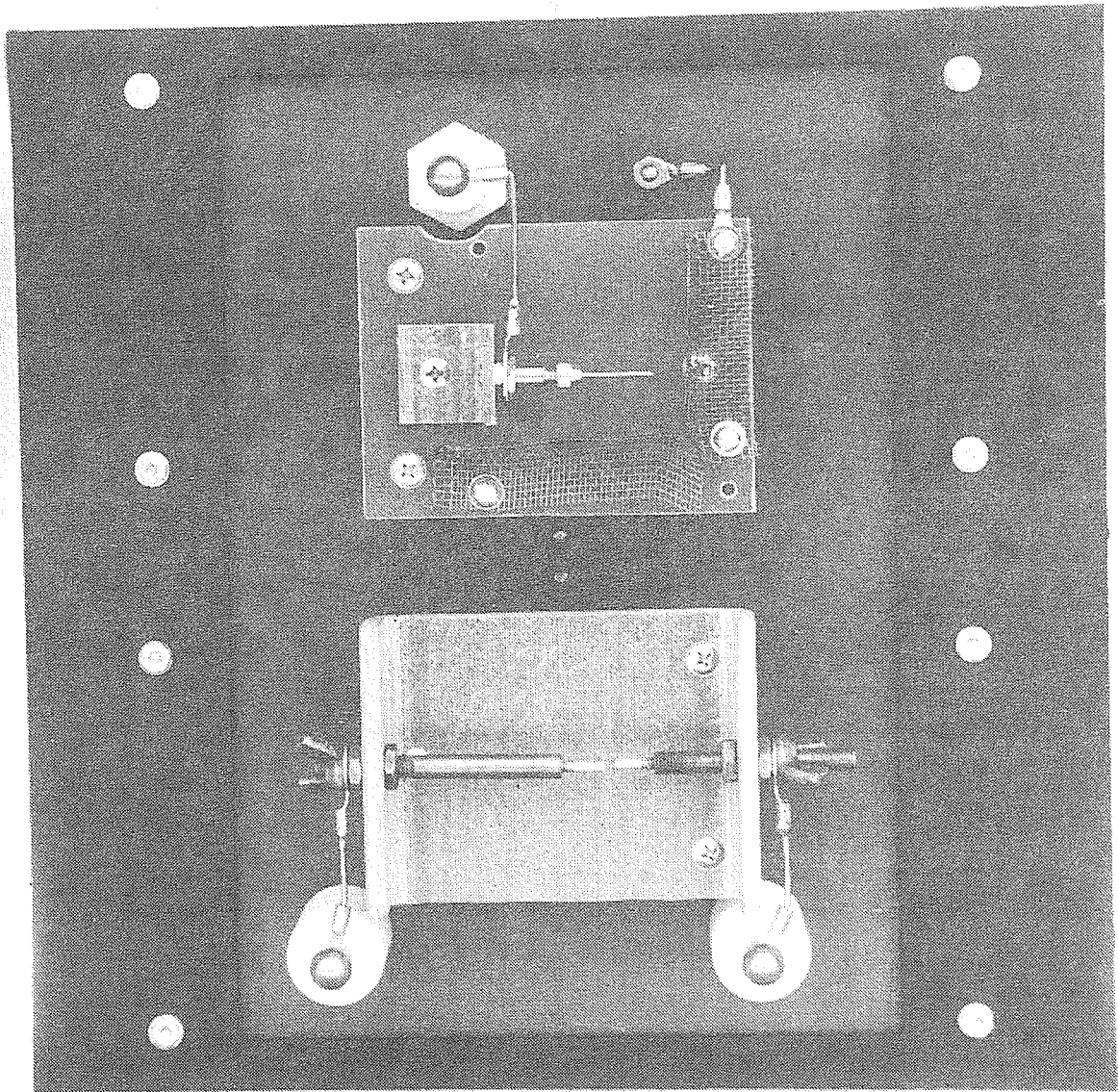

Source Module, Front View

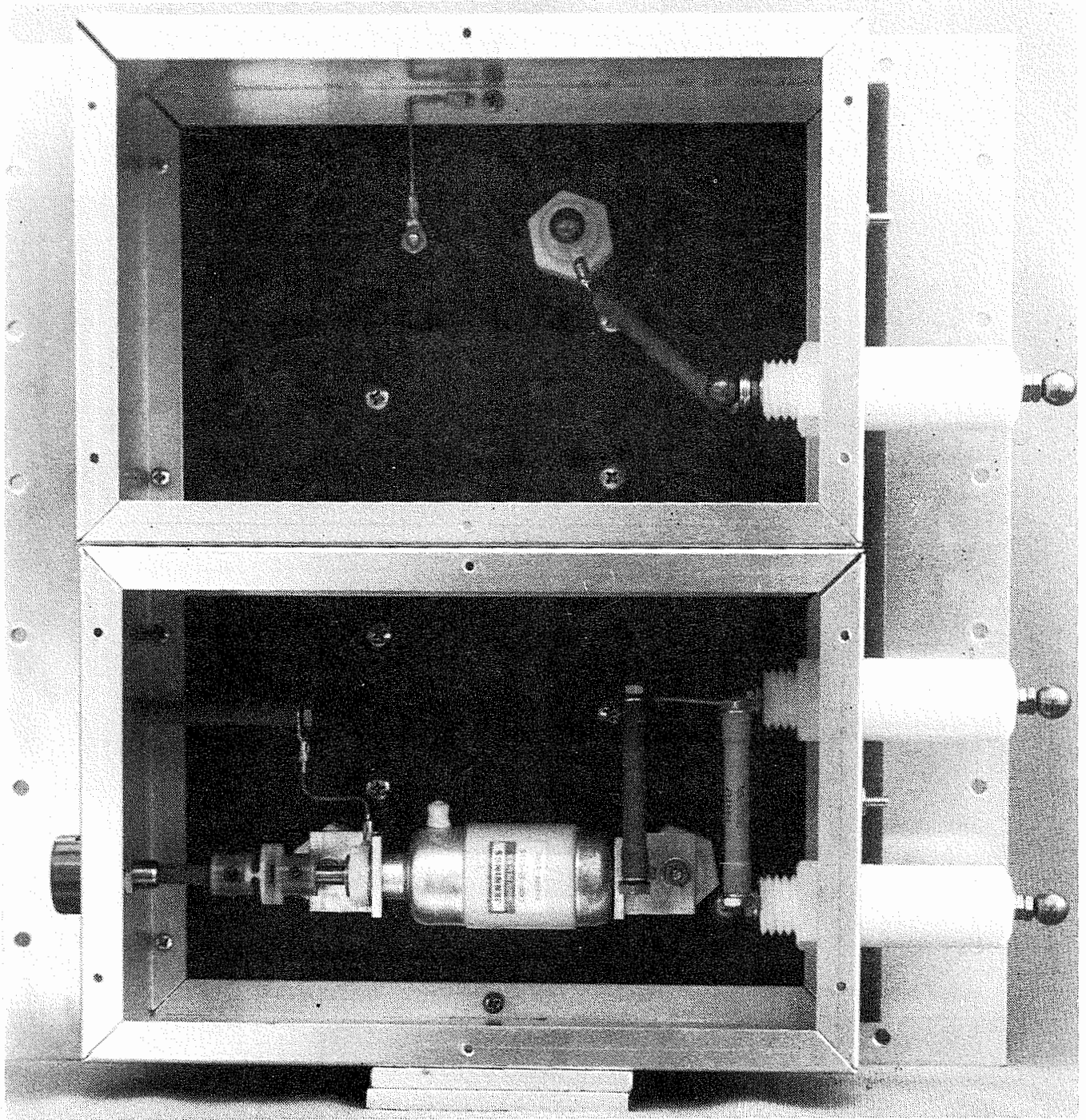

Source Module, Rear View

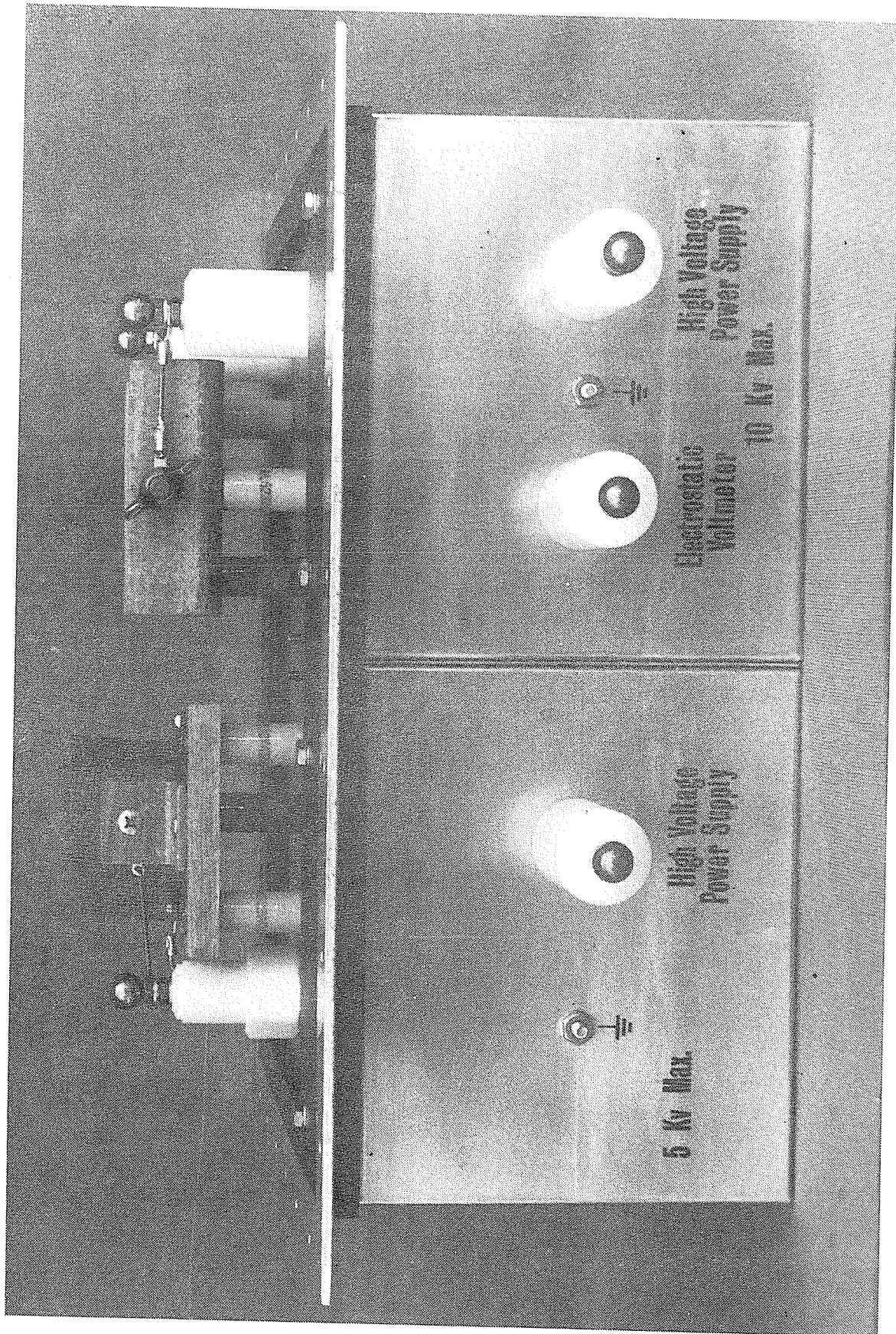

Source Module, Side View

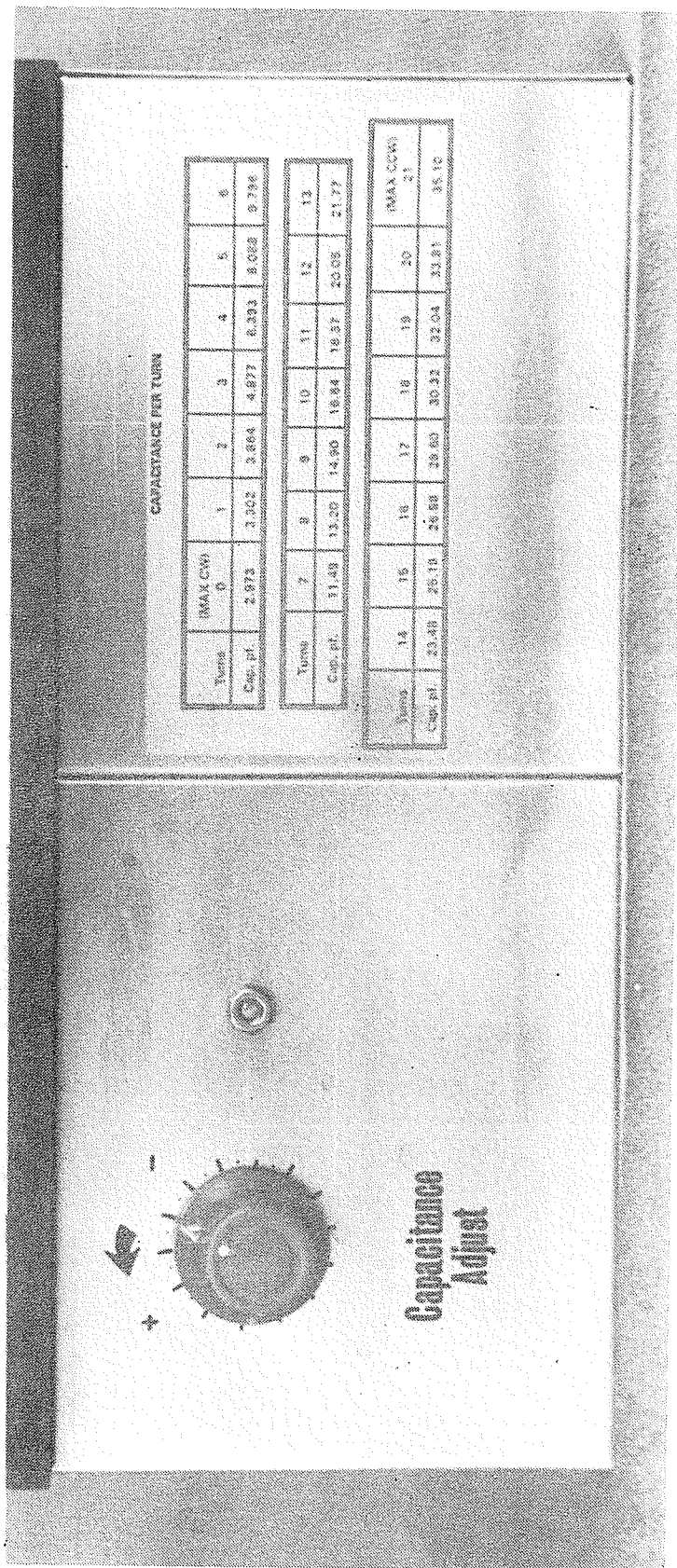
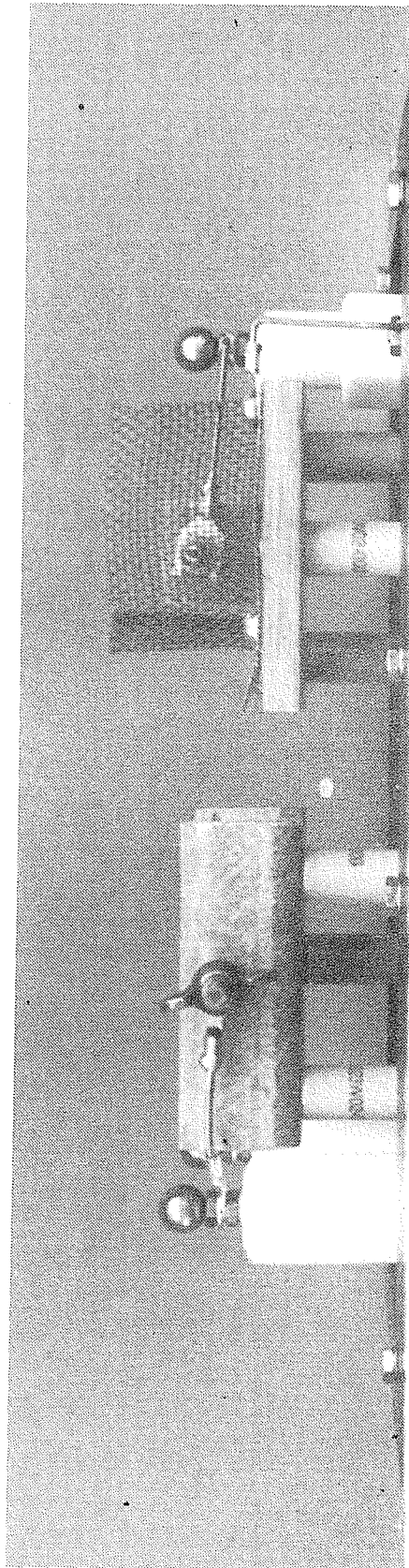

Source Module, Side View

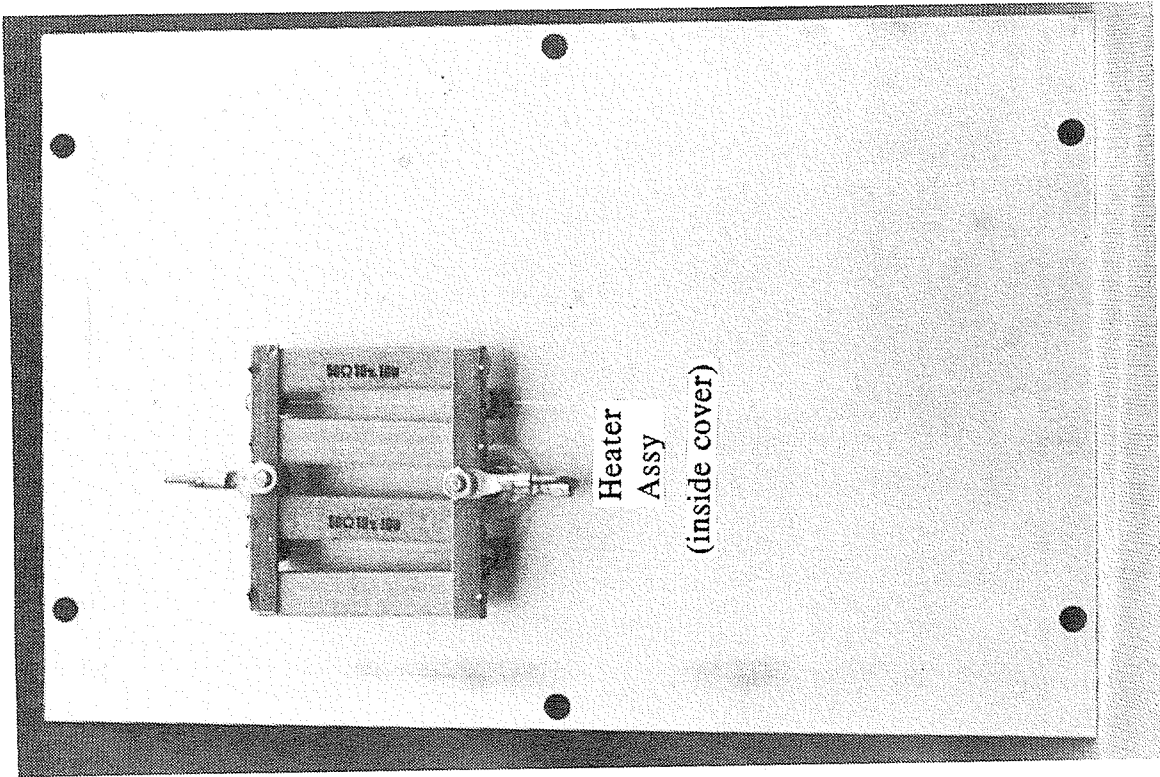
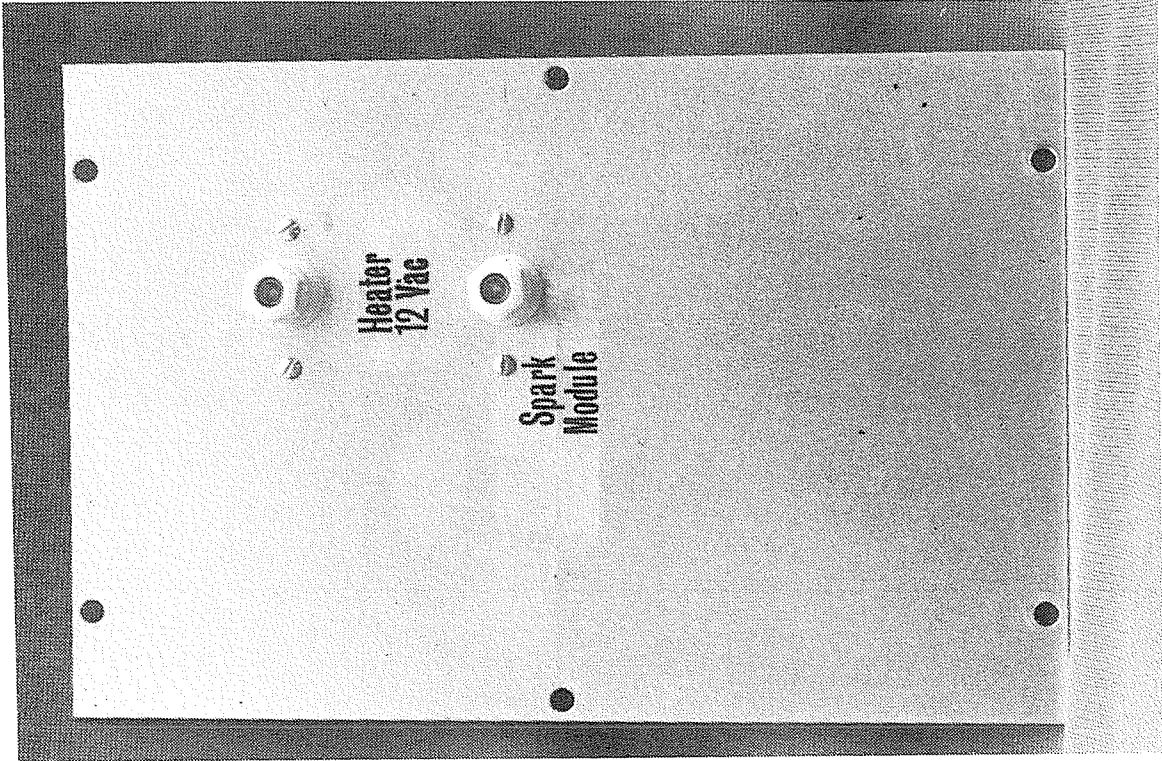

Heater Assembly (on Spark Module Cover)

6.0 REFERENCES

1. Von Elbe, G., Lewis, B., et al., *Ignition of Explosive Gas Mixtures by Electric Sparks*, Third Symposium on Combustion & Flame & Explosion Phenomena, Baltimore, MD, Williams & Wilkins Co., 1949.
2. E. Barreto, S. I. Reynolds, and H. Jurenka, *Ignition of Hydrocarbons and the Thermalization of Electrical Discharges*, Journal of Applied Physics, Vol. 45, No. 8, August 1974, pp. 3317-3327.
3. Crouch, K. E., *Aircraft Fuel System Lightning Protection Design and Qualification Test Procedures Development Investigation of Fuel Ignition Sources*, Naval Air Development Center Report No. NADC-86100-20, August 1986.
4. Crouch, K. E., *Development and Verification of a Standardized Spark Ignition Source*, International Conference on Lightning and Static Electricity, September 26-28, 1989.

APPENDIX C

LT-92-855

AIRCRAFT FUEL SYSTEM LIGHTNING
PROTECTION DESIGN AND
QUALIFICATION TEST PROCEDURES
DEVELOPMENT
STANDARD HOT SPOT
IGNITION SOURCE

Prepared by:

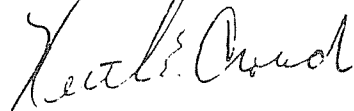

K. E. Crouch

Approved by:



J. Anderson Plumer

For

Federal Aviation Administration
Technical Center
Atlantic City Int'l Airport, NJ 08405

Contract No. DTFA03-92-C-00003

LTI Project No. 1074

October 1992

Lightning Technologies, Inc.
10 Downing Parkway
Pittsfield, MA 01201
U.S.A.

1. Report No.		2. Government Accession No.		3. Recipient's Catalog No.	
4. Title and Subtitle Aircraft Fuel System Lightning Protection Design and Qualification Test Procedures Development: Standard Hot Spot Ignition Source				5. Report Date October 1992 Revised 19 August 1993 7 January 1994	
				6. Performing Organization Code	
7. Author(s) Keith E. Crouch				8. Performing Organization Report No. LT-92-855 Revision B	
9. Performing Organization Name and Address Lightning Technologies, Inc. 10 Downing Parkway Pittsfield, MA 01201				10. Work Unit No. (TRAIS) DTFA03-92-C-00003	
				11. Contract or Grant No.	
12. Sponsoring Agency Name and Address DOT/FAA FAA Technical Center Atlantic City Int'l Airport, NJ 08405				13. Type of Report and Period Covered Interim Report	
				14. Sponsoring Agency Code	
15. Supplementary Notes					
16. Abstract A description of parts, and procedures for the construction and operation of a standard hot spot ignition source is presented. The theory of operation and operating precautions are included to supply the information necessary to properly use the system.					
17. Key Words Lightning Fuels Testing			18. Distribution Statement Qualification Design		
19. Security Classif. (of this report) Unclassified		20. Security Classif. (of this page) Unclassified		21. No. of Pages 36	22. Price

**AIRCRAFT FUEL SYSTEM LIGHTNING
PROTECTION DESIGN AND
QUALIFICATION TEST PROCEDURES
DEVELOPMENT
STANDARD HOT SPOT
IGNITION SOURCE

ISSUE AND APPROVAL RECORD**

Rev	By	Date	Rev App by	Pages Rev or Added
A	K. E. Crouch	19 August 1993	<i>KEC</i>	Revised and added text on Thermocouples
B	K. E. Crouch	7 January 1994	<i>KEC</i>	Revised Text on Calibration and Fastening Thermocouples

TABLE OF CONTENTS

SECTION	PAGE NO.
EXECUTIVE SUMMARY	iii
1.0 INTRODUCTION	1
2.0 THEORY OF OPERATION	1
3.0 OPERATING INSTRUCTIONS	2
4.0 PARTS LIST	8
4.1 Control Module	8
4.2 Source Module	11
5.0 DRAWINGS, SCHEMATICS, AND PHOTOGRAPHS	15
5.1 Control Module Block Diagram	15
5.2 Source Module Drawings	15
5.3 Photographs	15
6.0 REFERENCES	36

EXECUTIVE SUMMARY

The standard hot spot ignition source will be used to verify and calibrate the ignition detection technique(s) before the technique(s) is used during fuel system lightning design and/or qualification testing. The source will produce hot spots at levels below, at, or above that needed to ignite 1.2 stoichiometric propane/air mixtures (representative of the threat in aircraft fuel systems).

A complete description of the parts, assembly, calibration, and operating procedures for constructing and operating an adjustable level hot spot ignition source is presented. The theory of operation is included to acquaint users with the necessary information to properly use the system.

1.0 INTRODUCTION

Lightning strikes to aircraft may result in several conditions which can cause ignition hazards in the fuel system. These ignition hazards have been divided into three categories:

1. Voltage Sparks
2. Hot Spots
3. Thermal Sparks

This document describes a fixture which will provide a standard hot spot ignition source (SHSIS). The fixture is designed so that the intensity of the source can be varied to operate at levels corresponding to a very high or a very low probability of igniting a fuel/air mixture.

When lightning tests are conducted on fuel system components, the response must be monitored to ensure that no ignition hazards exist. The ignition detection techniques used to monitor the tests must be calibrated to verify that they will detect the ignition hazard. Further, the detection technique must be capable of determining if the ignition source detected is below, at, or well above the criterion established for pass/fail on this particular component.

The SHSIS fixture is designed to be installed in a lightning test area to verify the ignition detection technique to be used for that test series. The fixture is semi-portable and can be operated from 120 V ac. The fixture consists of a source module, a control module and the instrumentation module. The source module holds the foil and a thermocouple which monitors the applied temperature pulse. The control module supplies the energy to heat the foil to various selected temperature levels and durations. The control module also contains the ice point thermocouple reference. The instrumentation module consists of a monitor (a digital storage oscilloscope or other suitable recorder) which records and processes the output of the thermocouple.

2.0 THEORY OF OPERATION

Tests carried out by Laurendeau, Demetri, and Crouch (Ref. 1, 2, and 3) have shown that heated surface temperatures can ignite fuel/air mixtures. Approximately 1.6 cm^2 - 0.25 in.^2 (on one side, both sides exposed to the fuel), heated for 1.0 s and immersed in the proper stoichiometric fuel/air mixture, ignites at temperatures above 900°C .

The foil heats a small volume (dV) of mixture at the surface(s) to a temperature near that of the foil. When this temperature reaches a critical level, a chemical reaction (burning) between the fuel and the oxygen in the air takes place. When the heat released by burning the volume (dV) next to the foils heats additional volumes to the burning temperature, the process becomes self propagating and a flame front is established which moves through the rest of the fuel/air volume, burning all of the fuel.

The energy deposited in the fuel/air mixture depends on the electrical energy deposited in the foil. The mass of the foil is very small and most of the heat (excluding that conducted to the holders) will be transferred to the fuel/air mixture very quickly. To vary the energy supplied, the SHSIS described here has both a variable current level and time duration.

The intent of the circuit is to subject the fuel/air mixture to a heat pulse with a relatively square shape as a function of time. Since the foil resistance changes considerably over the temperature range of interest, a compound circuit is used to achieve the best result. Initially the foil is cold and has a low resistance. Discharging a capacitor bank into the foil will quickly raise its' temperature and resistance. The initial current pulse is followed by a constant current level selected to maintain the temperature of the foil. These levels will have to be determined experimentally, since the foil resistance will vary somewhat from assembly to assembly. Typical pulse and hold current oscillograms are given in Figure 1. At 800°C, pulse currents of 4,000 A and hold currents of 100 A are needed.

The temperature rise time of the foil assembly is on the order of a few milliseconds. At the present time, there does not appear to be any commercially available optical infrared pyrometers with response times less than a few 100 milliseconds, especially with the temperature range of 200 to 1,000°C as would be needed in this application. In addition, the foil, stainless steel, is quite reflective and the emissivity factor is very hard to accurately establish, especially with time and repeated use.

Fine wire thermocouples, .002 inch diameter, have response times which are adequate for this application. The thermocouple junction must be attached to the center of the foil assembly. A thermocouple measurement of foil temperature is shown in Figure 2.

3.0 OPERATING INSTRUCTIONS

The thermocouple junction bead must be spot welded to the foil surface with the proper pressure and duration to insure adequate mechanical contact. If too much heat is applied, material from the foil will migrate into the junction altering the junction characteristics. If insufficient welding occurs the bead will not stay in place. If the electrode is not properly positioned over the bead, the bead should be just under the edge of the electrode with the leads positioned on the side opposite the electrode, damage to the leads can result. If one or both of the leads become welded to the foil surface at another point away from the junction bead, resistive voltages which are comparable or larger than the thermocouple signal may be introduced into the leads.

The welding process is not easy and can only be accomplished by some amount of experimentation. Different welding conditions must be applied and the results inspected and tested to attain an acceptable weld. Welds during the development of the SHSIS were done by Micro Arc Welding Service Company.

The finished foil assemblies should be calibrated to verify thermocouple integrity by placing the assembly in a small, inert gas, electric oven with another standard thermocouple

Pulse Current

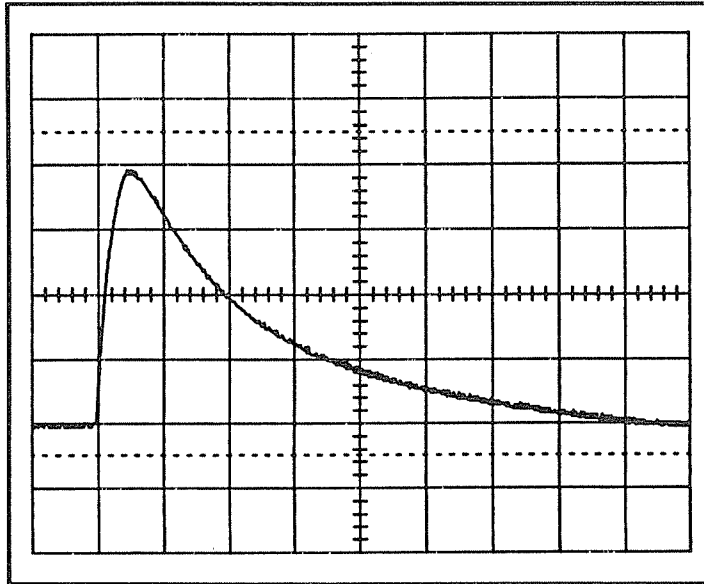

Foil Assy. No. 5
Pulse - 91 V
Hold - 4.1 V
1,000 A/div.
0.2 s/div.
1,000°C
4,000 Ap

Total Current

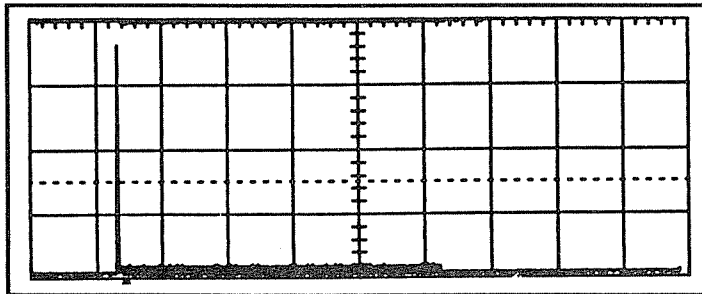

Pulse - 67 V
Hold - 4.1 V
1,000 A/div.
0.2 s/div.
Pulse - 3,550 Ap
Hold - 100 A
(Temperature not Recorded)

Figure 1 - Typical Foil Assembly Current

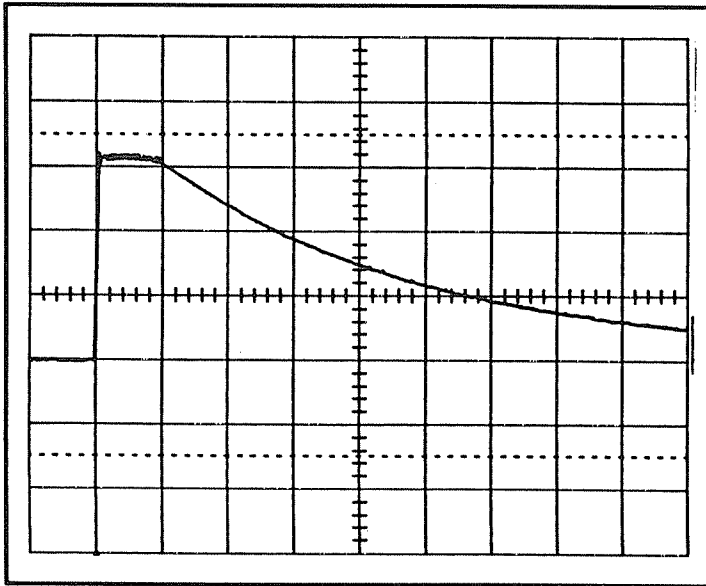

Foil Assembly No. 2
Pulse - 90 V
Hold - 3.4 V
20 mV/div.
1 s/div.
815°C

Figure 2 - Typical Temperature Measurement Using a Thermocouple

and comparing the reading obtained on the 0.002 Type E welded thermocouple with the other thermocouple. This will insure that welding has not altered the junction. The tests should be conducted at temperature levels at or above 500°C.

Whenever a foil assembly is installed in the source module, a calibration table relating pulse and hold setting versus temperature must be obtained. This is done without fuel in the chamber and all temperature levels expected during the test should be included. A typical table is shown in Figure 3. Once the settings have been verified for a specific foil assembly, they are very repeatable and can be used even after the thermocouple fails. The 0.002-inch wires are very fragile and will be destroyed by the first fuel ignition.

Changes between similar foil assemblies tend to be small but a small number will deviate significantly and no obvious difference has been noted to help identify them without conducting a calibration table.

It must be noted that foil assemblies are somewhat fragile and have a definite life, which is related to the temperature levels at which they are operated. At 1000°C, 5 to 10 pulses would be a good life expectancy. At lower levels, the life is much longer. Life is also related to the atmosphere around the foil. Propane or other gaseous mixtures are not usually detrimental, but evaporated liquids can significantly affect life since deposits will cause non-uniform heating, distortion, and eventual tearing of the thin foil. Consequently, several foil assemblies must be available during any test program.

Calibration involves determining the capacitor bank and follow current circuit settings which result in the desired temperature pulse from the foil assembly. The first step involves the selection of the temperature pulse duration. One second durations are typical for lightning strike tests.

Set the capacitor bank charge voltage to some level (greater than ten volts as the SCR switch will not operate below this level) and monitor the output temperature pulse with the thermocouple. Reset the charge level and repeat until the desired peak temperature results. Set an arbitrary follow circuit level and repeat. Reset follow current circuit settings until the desired temperature pulse is attained. Follow circuit settings will affect the peak temperature so final adjustments will be required in both circuits to attain the desired temperature pulse. After one level has been established, other levels can be estimated using ratios to get the preliminary settings.

Type E thermocouples exhibit the greatest voltage change (62 mV) over the temperature range of interest (200 to 1000°C). The magnitude and voltage levels are still extremely small. Detecting and recording these levels in the presence of the electrical currents generating the heat in the foil requires great care. The levels are too small (10's of mV) to be measured directly by general purpose oscilloscopes. The thermocouple signal must be amplified by a factor of 100 to be handled comfortably. The amplifier, and the cold junction reference, must be as close to the thermocouple as possible to reduce the amplified noise to as low a level as possible.

Pulse (V)	Hold (V)	Temperature (°C)
Foil Assembly No. 2		
82	3.2	700
90	3.4	825
93	3.5	900
94	4.0	940
96	4.2	970
98	4.5	1,000
Foil Assembly No. 4		
90	3.4	860
92	3.5	900
94	4.0	940
Foil Assembly No. 5		
90	3.4	950
91	4.1	1,000

Figure 3 - Typical Foil Assembly Pulse and Hold Voltage Setting Versus Temperature

The Type E thermocouple output voltage is not linear and must be converted to obtain temperature. A power expansion can be used to convert the voltage to temperature, which would be in the form of:

$$T = a_0 + a_1 E + a_2 E^2$$

Where:

T - Temperature in °C

a_0 - 0.0

a_1 - $+1.42 \cdot 10^2$

a_2 - -1.63

E - volts (after amplification)

This expansion will yield values within $\pm 1\%$ over a range of 400 to 1000°C.

Several digital storage oscilloscopes are available which can perform such calculations and display the results as a function of time.

Once the system is calibrated and settings have been determined for obtaining the required test levels, the system is ready for operation. The following operating instructions detail the test use of the SHSIS.

Warning: Voltages associated with the use of this equipment are lethal. Care must be exercised at all times.

1. Install the source module in or on the test chamber in which the tests are to be conducted. Be sure it is within the space monitored by the detection technique to be calibrated.

Note: Handle the foil with care to prevent damage or contamination.

2. Connect the leads from the control module and the oscilloscope to the appropriate terminals on the source module.
3. Apply power to the control module.
4. Press the interlock reset button. The interlock light will extinguish and the operate light will illuminate.

Note: It will not be necessary to repeat this step unless the primary power to the control module is interrupted.

5. Turn on the main power switch. The dump and operate lights will illuminate.
6. Adjust the output timer to the desired duration.

7. Turn on pulse and hold power supplies. The indicator lights of each will illuminate and the dump light will extinguish.
8. Adjust the pulse and hold power supplies to the desired levels necessary to attain the desired temperature on the foil.
9. Close chamber (as required), activate the detection technique system and verify readiness as necessary.
10. Clear area around source module of personnel

CAUTION: VOLTAGES USED ARE LETHAL

11. Press the fire button. Fire lamp will illuminate and remain on until the output timer interrupts the circuit. At that time, the fire, operate, pulse, and hold lights will extinguish and the reset and dump lamps will illuminate.
12. Record the data obtained.
13. Verify detection technique response. If additional tests are required, place the pulse and hold power switches in the off position. Press the reset button. The reset lamp will extinguish and the operate light will illuminate. Repeat starting at step 7 as required.

4.0 PARTS LIST

The following parts are suggested for the SHSIS fixture. A prototype was assembled at Lightning Technologies, Inc. using these parts, and was found to operate satisfactorily. Some of the parts do have equivalent substitutes which will also operate satisfactorily, but only those parts listed here were verified.

4.1 Control Module

- 4.1.1 Cabinet, Rack, Bud Cat. No. CR-1739
- 4.1.2 Transformer: 120/240 Primary, 16/32 Secondary
Jefferson Electric No. 216-1271
- 4.1.3 Isolation Transformer 500 VA 120:120
Stancor No. GIS-500
- 4.1.4 Variac 15 A
Staco No. 1510
- 4.1.5 Variac 5 A
Staco No. 501

4.1 Control Module (continued)

- 4.1.6 Relay: 120 VAC, SPDT-NC-NO 30 A (2 Required)
Magnecraft No. W389ADZCX-4
- 4.1.7 Time Delay Relay: 0.1 sec - 2 hours 120 VAC
Macromatic No. SS 60222
- 4.1.8 Relay: 120 VAC, DPDT 5 A
Magnecraft No. W388ACQX-9
- 4.1.9 Relay: 120 VAC, DPDT 20 A
Magnecraft No. W389ACX-9
- 4.1.10 Pushbutton Switch: 20 A Push-Pull(reset), SPDT, (2 Required)
Cherry No. E69-20A
- 4.1.11 Momentary Switch: 5 A OFF-(ON) SPDT
Eaton Arrow Hart No. 80631
- 4.1.12 Toggle Switch: 20 A OFF-ON DPDT (2 Required)
Eaton Arrow Hart No. 80421U
- 4.1.13 Momentary Switch: 6 A ON-(ON) DPDT
Eaton Arrow Hart No. 81087J
- 4.1.14 Momentary Switch: 6 A OFF-(ON) DPST
Eaton Arrow Hart No. 81084-G
- 4.1.15 Toggle Switch: 6 A OFF-ON SPST
Eaton Arrow Hart No. 81015-AW
- 4.1.16 Rectifier: (4) High Current Diodes
International Rectifier No. 1N3290
- 4.1.17 Rectifier: (4) High Current Diodes
International Rectifier No. 12F120
- 4.1.18 High Current Diode
International Rectifier No. 1N3290
- 4.1.19 10 V Zener Diode 5W
Fagor No. 1N5347B
- 4.1.20 Phase Control Thyristor (SCR): 110 A 400 V
International Rectifier No. 2N1798

4.1 Control Module (continued)

- 4.1.21 T-2 Pilot Lamps: 120 VAC (2 Required)
GTE Sylvania No. 120PSB
- 4.1.22 3AG 15 A Fuse
Littlefuse No. 312005
- 4.1.23 3AG 5 A Fuse
Littlefuse No. 311015
- 4.1.24 100 A Rectifier Fuse
Cooper/Bussman No. FWH-100A
- 4.1.25 4 1/2 Digit DC Panel Meter
Simpson No. 24862 (Hold Circuit)
- 4.1.26 4 1/2 Digit DC Panel Meter
Simpson No. 24863 (Pulse Circuit)
- 4.1.27 Electrolytic Capacitor: 12,000 μ F 250 VDC (2 Required)
Sprague No. 36DX123F250DJD
- 4.1.28 Film Capacitor: 100 VDC
Sprague No. 225P10591YD3
- 4.1.29 DC Power Supply: 5 VDC
Sola No. SLS-05-030-1
- 4.1.30 Wire, AWG No. 6 (To connect Control Module with Source Module)
- 4.1.31 Wire, AWG No. 22 (To connect Ice Point to Instrument Amplifier)
- 4.1.32 Wire, AWG No. 10 (Control Module high power internal connections)
- 4.1.33 Wire, AWG No. 14 (Control module 120 VAC and other internal connections)
- 4.1.34 100 A Receptacle - RED (DC output to Source Module)
Superior Electric No. RS100GR
- 4.1.35 100 A Receptacle - BLACK (DC output to Source Module)
Superior Electric No. RS100GB
- 4.1.36 100 A Plug - RED (DC output to Source Module)
Superior Electric No. PP100GR

4.1 Control Module (continued)

4.1.37 100 A Plug - BLACK (DC output to Source Module)
Superior Electric No. PP100GB

4.1.38 Fuse Holder
Littlefuse No. 342014A

4.1.39 Lamp Housing
GTE Sylvania No. 30099

4.1.40 Lens Cap Assembly - RED
GTE Sylvania No. 30100

4.1.41 Lens Cap Assembly - GREEN
GTE Sylvania No. 30102

4.1.42 Lens Cap Assembly - AMBER
GTE Sylvania No. 30106

4.1.43 1/2 Watt Carbon Resistor 56 k (7 Required)
Allen Bradley No. RC20 EB

4.1.44 Wire Wound Resistor 100 Ohms
Lightning Technologies, Inc.

4.1.45 1/2 Watt Carbon Resistor 1 k $\pm 10\%$
Allen Bradley No. RC20 EB

4.1.46 1/2 Watt Carbon Resistor 56 k
Allen Bradley No. RC20 EB

4.1.47 1/2 Watt Carbon Resistor 100 Ohms
Allen Bradley No. RC20 EB

4.1.48 1/2 Watt Carbon Resistor 22 Ohms
Allen Bradley No. RC20 EB

4.1.49 Assorted Hardware

4.2 Source Module

4.2.1 Spacer (2 Required)

4.2.2 Washer, Spring

4.2 Source Module

4.2.3 Holder, Movable

4.2.4 Holder, Stationary

4.2.5 Guide, Stationary Holder - Mechanical TFE Teflon

4.2.6 Guide, Movable Holder - Mechanical TFE Teflon

4.2.7 Mount - 3/8 in. Yorolite G11 (2 Required)

4.2.8 Mounting Plate - 3/8 in. Yorolite G11

4.2.9 Spring

4.2.10 Foil Assembly

4.2.11 Support, Foil (4 Required)

4.2 Source Module (continued)

4.2.12 Foil

4.2.13 Thermocouple, Fine Wire, Type E
OMEGA CHCO-002

4.2.14 Miniature Electronic Ice Point Compensator
OMEGA Model MCJ-E

4.2.15 Thermocouple Insulator
OMEGA TRM 0418 (Cut to 1 3/4 inch long)

4.2.16 Instrumentation Amplifier
OMEGA OMNI-AMP 111 (includes 120:12 VAC Power Module)

Manufacturers List

Bud Industries, Inc.
4605 East 355th St.
P.O.Box 431
Willoughby, OH 44094
(216) 946- 3200

Manufacturers List (continued)

Jefferson Electric
427 East Stewart St.
Milwaukee, WI 53201
(708) 806-6500

Stancor
131 Godfier St.
Logansport, IN 46947
(219) 753-0600

Staco Energy Products Co.
Dayton, OH 45403
(513) 253-1191

Magnecraft Electric Co.
Northbrook, IL 60062-5376
(708) 564-8800

Milwaukee Electric Corp.
Macromatic Division
Milwaukee, WI 53223
(414) 358-4000

Cherry Corporation
Cherry Electric Products
Waukegan, IL 60087
(708) 360-3500

Cooper Industries
Eaton Arrow Hart
Charlottesville, VA 22906
(804) 974-5100

International Rectifier
233 Kansas St.
El Segundo, CA 90245
(213) 772-2000

Cotronics Corp.
3379 Shore Parkway
Brooklyn, NY 11235

Manufacturers List (continued)

Fagor
2250 Estes Ave.
Elk Grove Village, IL 60007
(800) 888-9863

GTE Sylvania Lighting
Sylvania Lighting Center
Danvers, MA 01923
(508) 777-1900

Littlefuse
800 East-Northwest Highway
Des Plaines, IL 60016
(708) 824-0400

Simpson Electric
Elgin, IL 60120
(708) 697-2260

Sprague Electric Corporation
San Diego, CA 92154-3483
(619) 575-9353

Sola, A Unit of General Signal
Elk Grove Village, IL 60007-5666
(708) 439-2800

Superior Electric Company
Bristol, CT 06010
(203) 582-9561

Micro Arc Welding Service Co.
33 Pullman Street
Worcester, MA 01606
(508) 852-6125

Bussman-Cooper Industries
P.O.Box 14460
St. Louis, MO 63178
(314) 394-2877

McMaster-Carr
P.O.Box 440
New Brunswick, NJ 08903-0440
(908) 329-3200

5.0 DRAWINGS, SCHEMATICS, AND PHOTOGRAPHS

Drawings of parts which must be fabricated (or were fabricated at Lightning Technologies, Inc.) follow as well as circuit schematics and photographs of the assembled parts.

5.1 Control Module Block Diagram

- 5.1.1 Control Circuit Schematic
- 5.1.2 Hold Circuit Schematic
- 5.1.3 Pulse Circuit Schematic
- 5.1.4 Schematic Symbol List

5.2 Source Module Drawings

- 5.2.1 Spacer
- 5.2.2 Washer, Spring
- 5.2.3 Holder Movable
- 5.2.4 Holder Stationary
- 5.2.5 Guide, Stationary Holder
- 5.2.7 Guide, Movable Holder
- 5.2.8 Mount
- 5.2.9 Mounting Plate
- 5.2.10 Foil Assembly
- 5.2.11 Support, Foil
- 5.2.12 Foil

5.3 Photographs

- 5.3.1 Source Module, Front and Rear Views
- 5.3.2 Control Module, Front and Rear Views
- 5.3.3 Control Module, Upper Shelf
- 5.3.4 Control Module, Lower Shelf

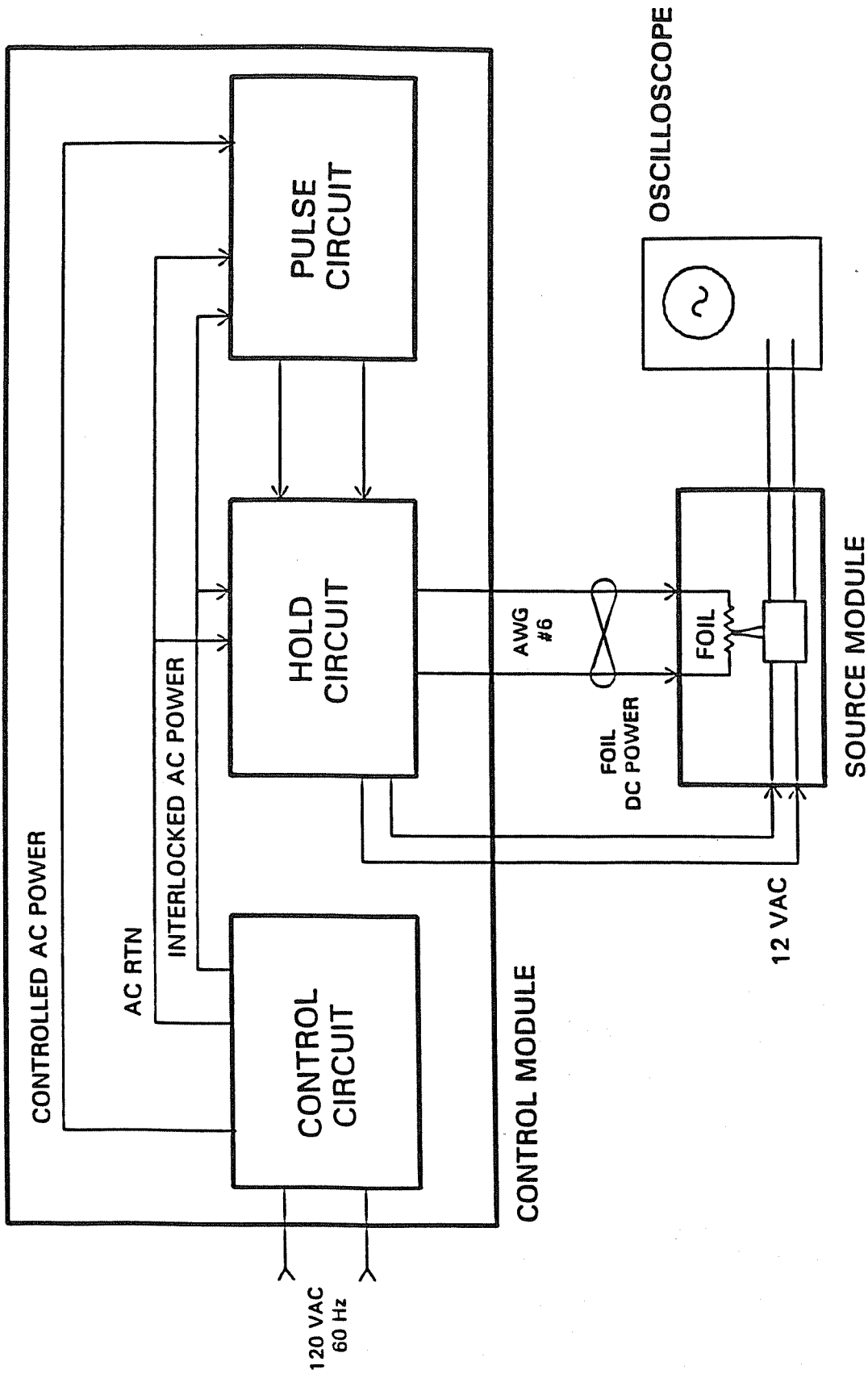

Hot Spot Ignition Source

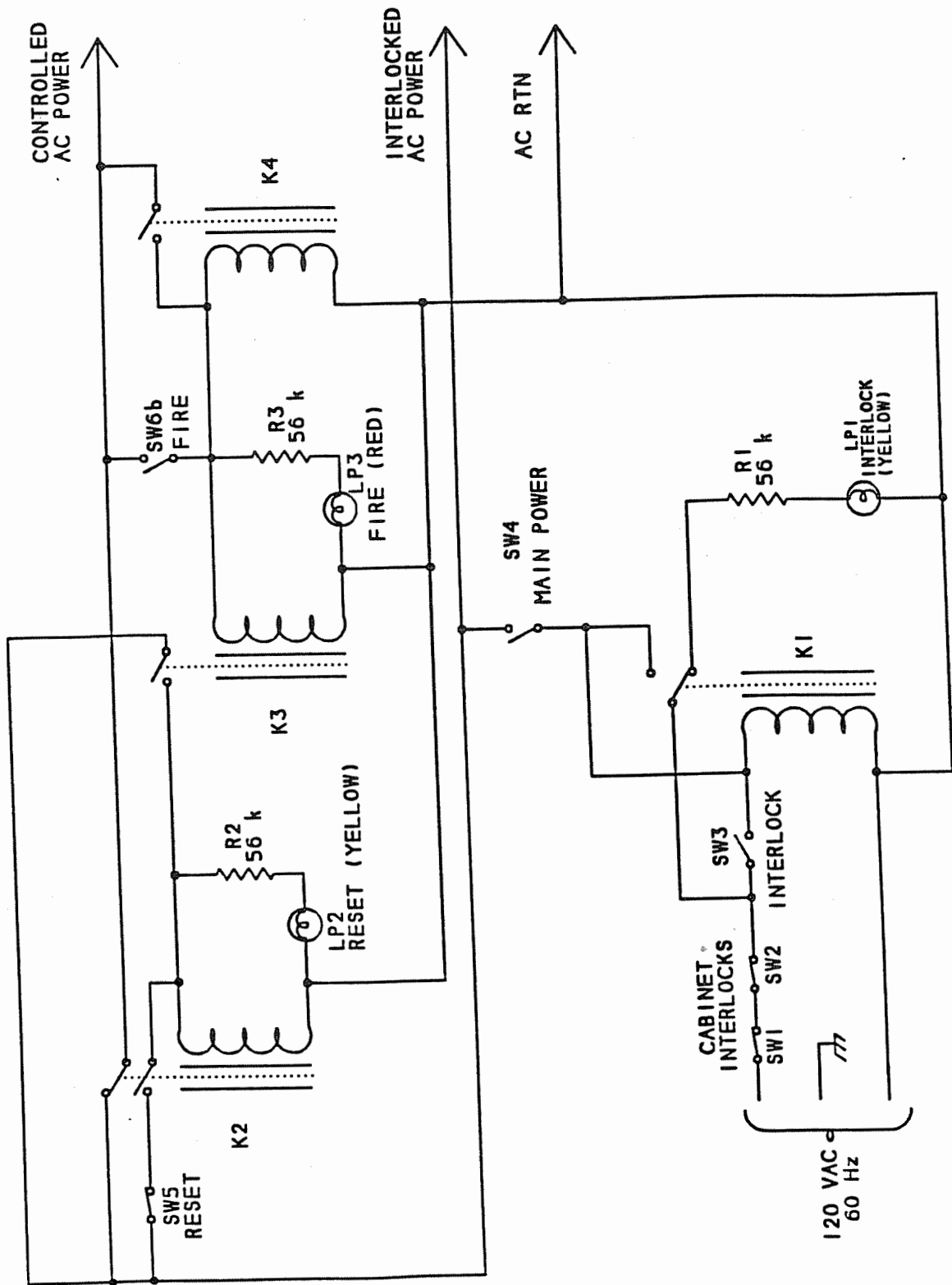

Control Circuit

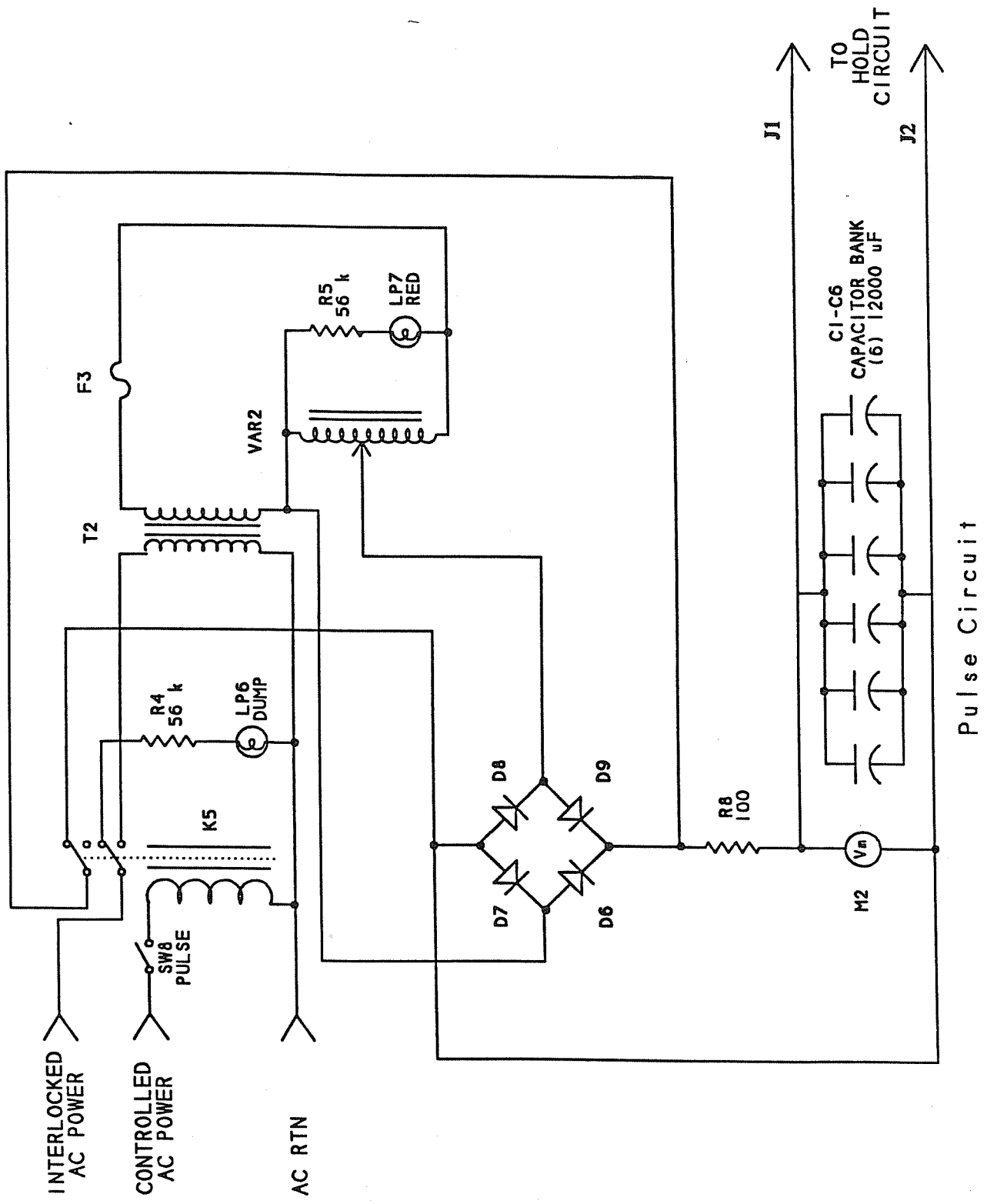

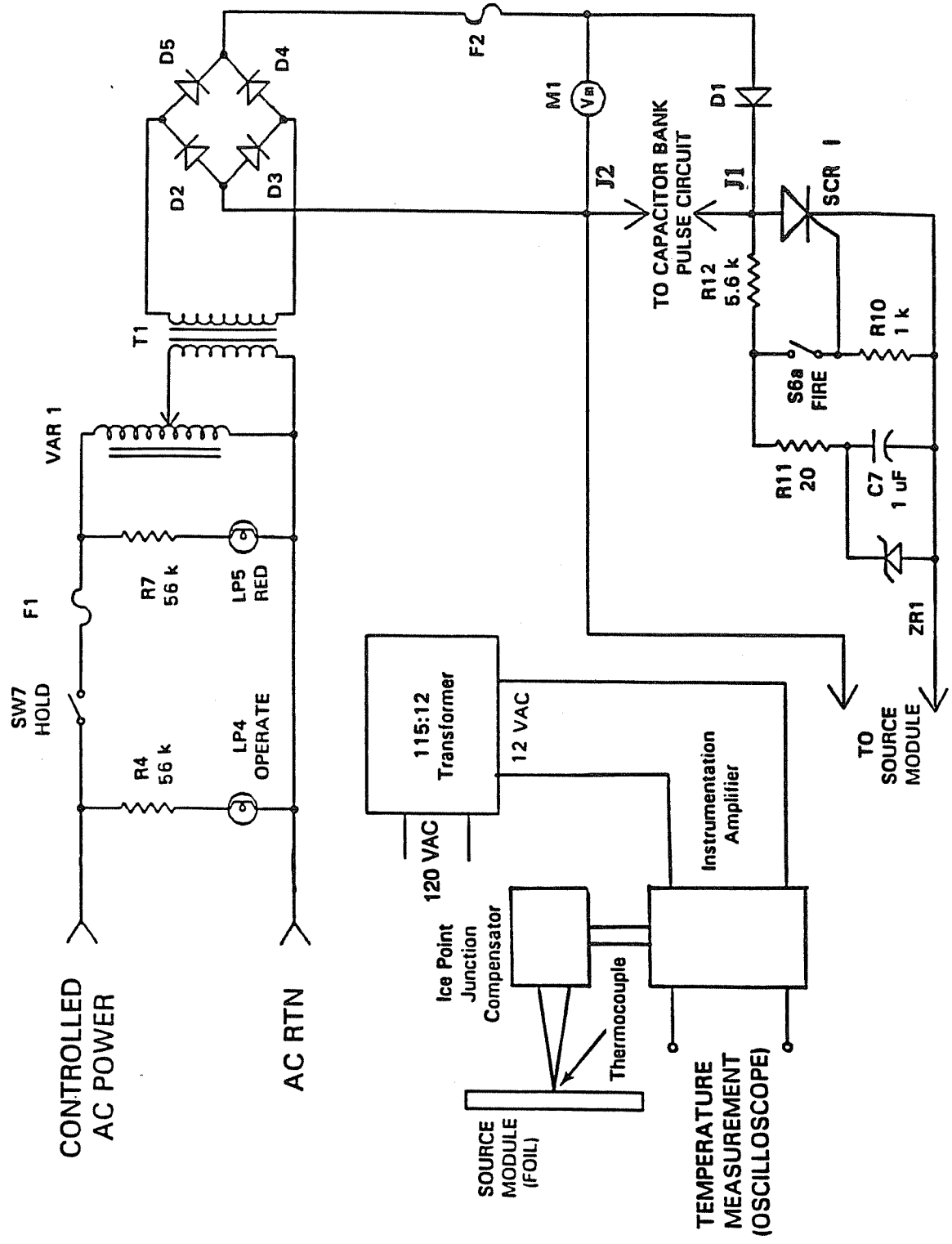

Hold Circuit

**SCHEMATIC DIAGRAM
SYMBOLS LIST**

T1	Transformer 120:16 VAC	4.1.2
T2	Isolation Transformer 500 VA	4.1.3
VAR1	Variac 15 A	4.1.4
VAR2	Variac 5 A	4.1.5
K1, K2	SPDT-NC-NO 30 A Relay:120 VAC	4.1.6
K3	Time Delay Relay: 0.1 sec - 2 hours 120 VAC	4.1.7
K4	DPDT 5 A Relay: 120 VAC	4.1.8
K5	DPDT 20 A Relay: 120 VAC	4.1.9
SW1, SW2	SPDT Pushbutton Switch: 20 A Push-Pull(reset)	4.1.10
SW3	SPST Momentary Switch: 5 A OFF-(ON)	4.1.11
SW4, SW7	DPST Toggle Switch: 20 A OFF-ON	4.1.12
SW5	DPDT Momentary Switch: 6 A ON-(ON)	4.1.13
SW6	DPST Momentary Switch: 6 A OFF-(ON)	4.1.14
SW8	SPST Toggle Switch: 6 A OFF-ON	4.1.15
D2-D5	Rectifier: (4) High Current Diodes 100 A	4.1.16
D6-D9	Rectifier: (4) High Current Diodes 5 A	4.1.17
D1	High Current Diode	4.1.18
ZR2	10 V Zener Diode	4.1.19
SCR1	Phase Control Thyristor (SCR): 110 A 400 V	4.1.20
LP1-LP7	T-2 Pilot Lamps: 120 VAC	4.1.21
F1	AG 15 A use	
	4.1.22	
F2	3AG 5 A Fuse	4.1.23
F3	100 A Rectifier Fuse	4.1.24
M1	4 1/2 Digit Panel Meter: 0-20 VDC	4.1.25
M2	4 1/2 Digit Panel Meter: 0-200 VDC	4.1.26
C1-C6	Electrolytic Capacitor: 250 VDC, 1200 μ F	4.1.27
C7	Film Capacitor: 100 VDC	4.1.28
R1-R7	1/2 Watt Carbon Resistors 56 k Ohms, \pm 10%	4.1.42
R10	1/2 Watt Carbon Resistors 1 k Ohms, \pm 10%	4.1.44
R12	1/2 Watt Carbon Resistor 5.1 k Ohms	4.1.45
R8	200 Watts Wire Wound Resistor 100 Ohms	4.1.46
R11	1/2 Watt Carbon Resistor 20 Ohms	4.1.47
TC	Type E Thermocouple, .002 Wire	4.2.17
IPSC	Ice Point Junction Compensation	4.2.13
IAMP	Instrumentation Amplifier	4.2.19
	12 VAC PS (Supplied with IAMP)	

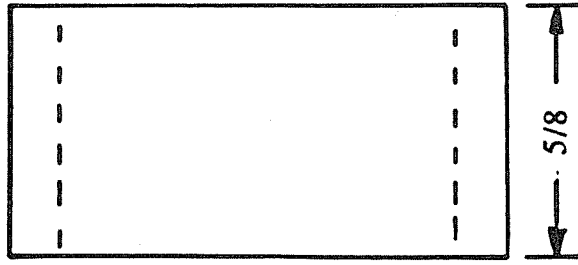
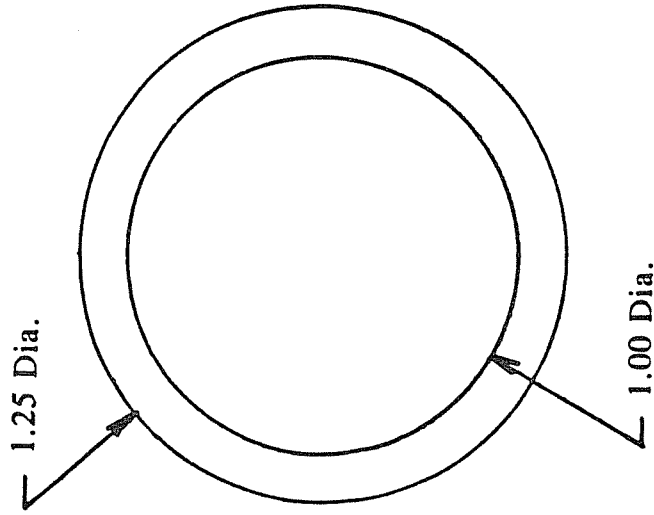

Material - Aluminum

Tolerance: XXX ± .005
 XX ± .010
 X ± .015
 X/X ± 1/32

Note: Features and locations may not all be to scale.

All dimensions are in inches.

Spacer

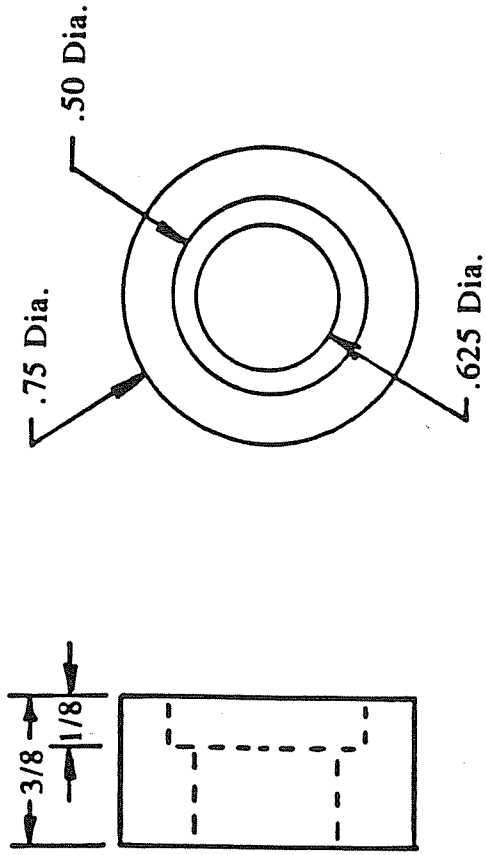

Material - Mechanical TFE Teflon

Tolerance: XXX $\pm .005$
 XX $\pm .010$
 X $\pm .015$
 X/X $\pm 1/32$

Note: Features and locations may not all be to scale.

All dimensions are in inches.

Washer, Spring

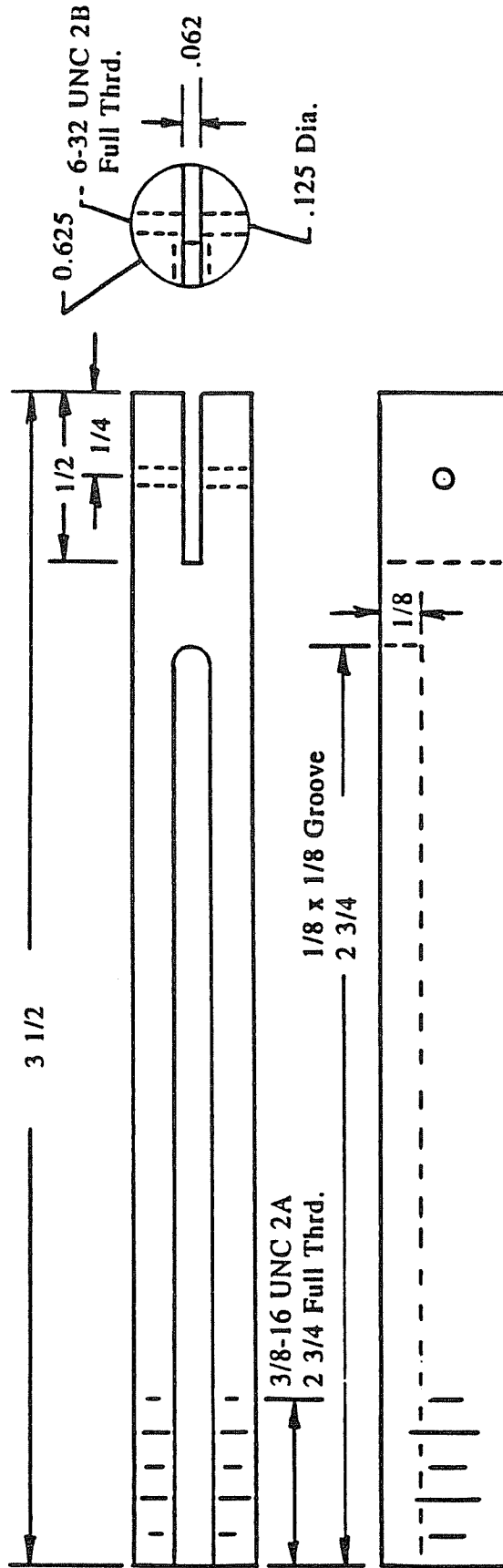

Note: Features and locations may not all be to scale.

All dimensions are in inches.

Tolerance: XXX ± .005
 XX ± .010
 X ± .015
 X/X ± 1/32

Material - 3/8 Brass Rod

Holder, Moveable

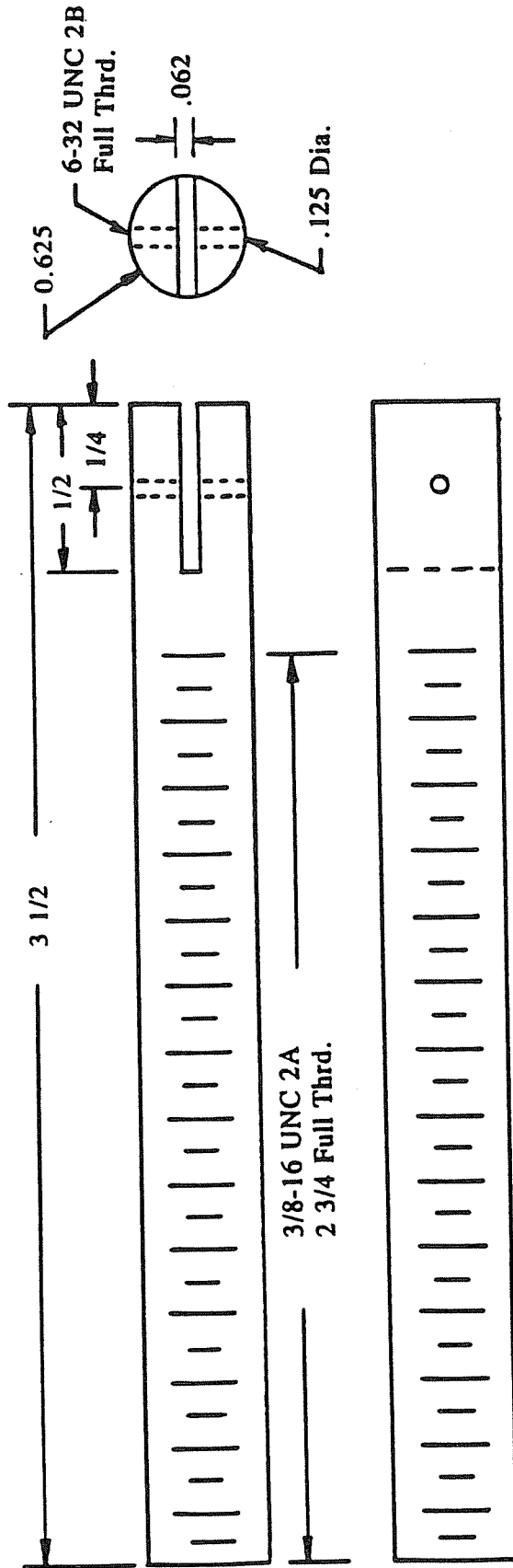

Material - 3/8 Brass Rod

Tolerance: XXX ± .005
 XX ± .010
 X ± .015
 X/X ± 1/32

Note: Features and locations may not all be to scale.

All dimensions are in inches.

Holder, Stationary

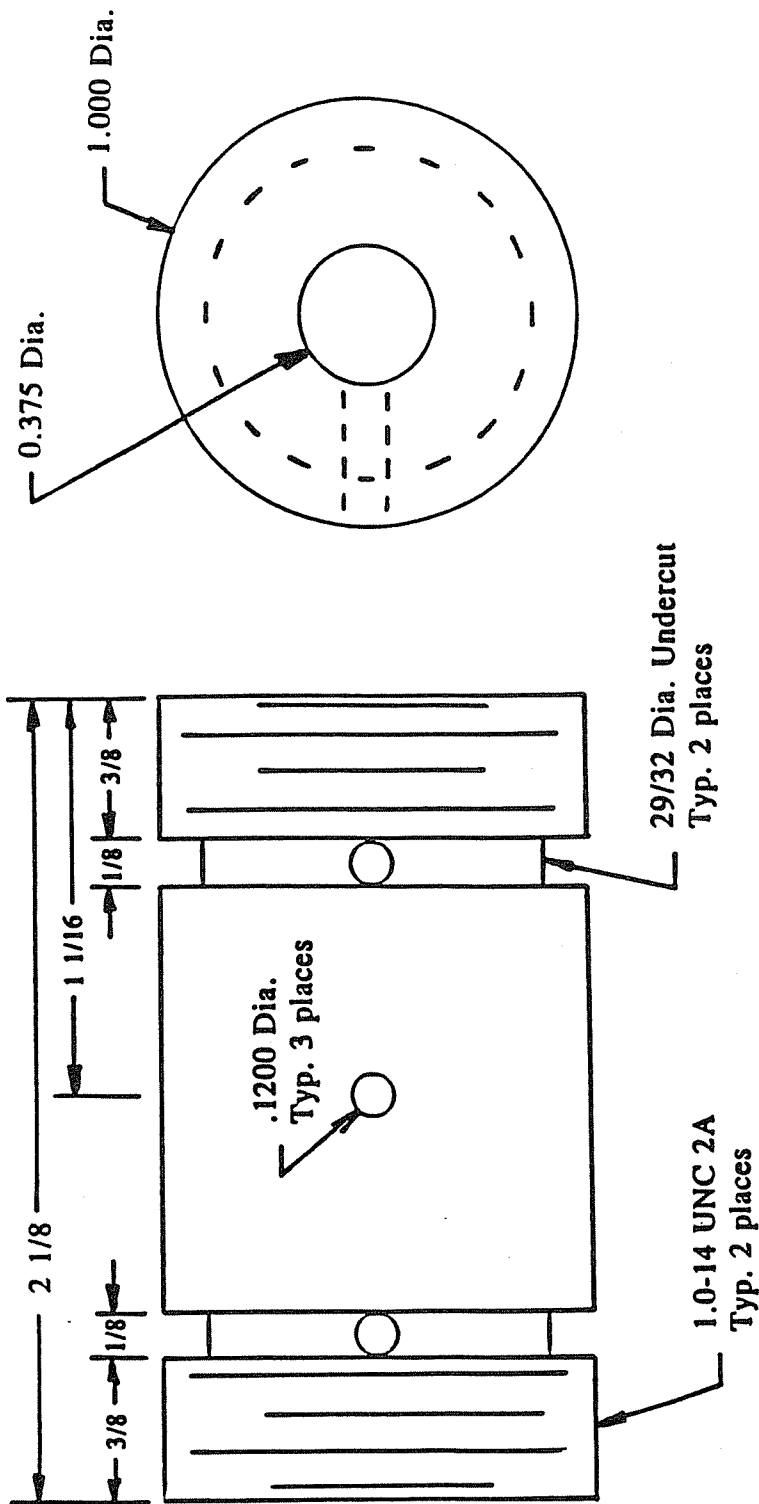

Material - Mechanical TFE Teflon

Tolerance: $XXX \pm .005$
 $XX \pm .010$
 $X \pm .015$
 $X/X \pm 1/32$

Note: Features and locations may not all be to scale.
 All dimensions are in inches.

Guide, Moveable Holder

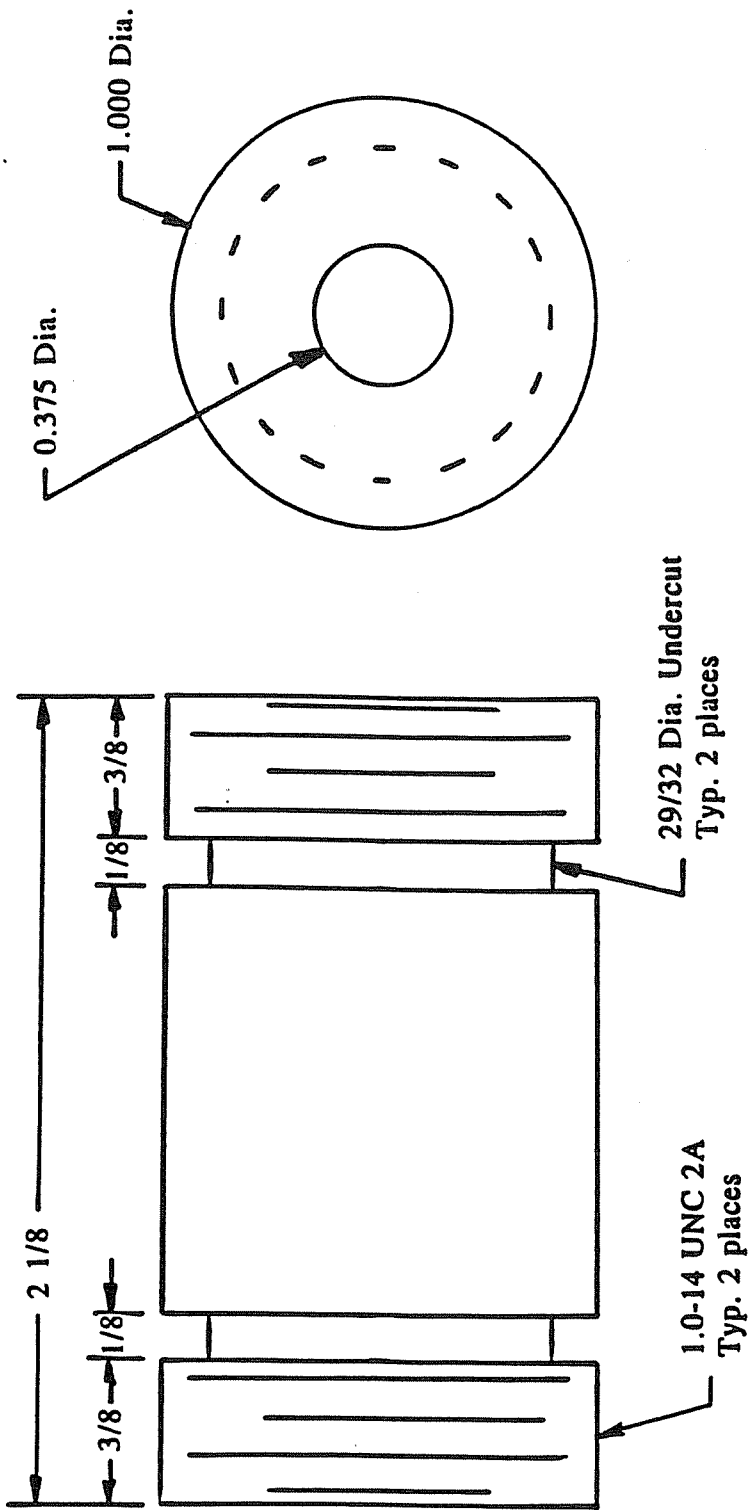

Material - Mechanical TFE Teflon

Tolerance: XXX $\pm .005$
 XX $\pm .010$
 X $\pm .015$
 X/X $\pm 1/32$

Note: Features and locations may not all be to scale.

All dimensions are in inches.

Guide, Stationary Holder

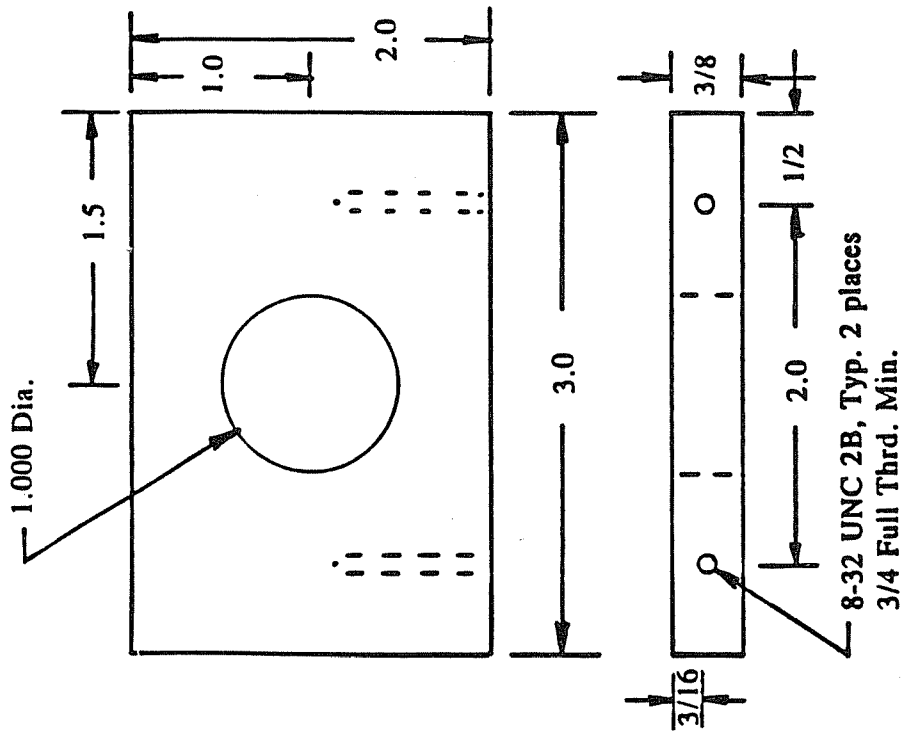

Material - 3/8 Yorolite G11

Tolerance: XXX ± .005
 XX ± .010
 X ± .015
 X/X ± 1/32

Note: Features and locations may not all be to scale.
 All dimensions are in inches.

Mount

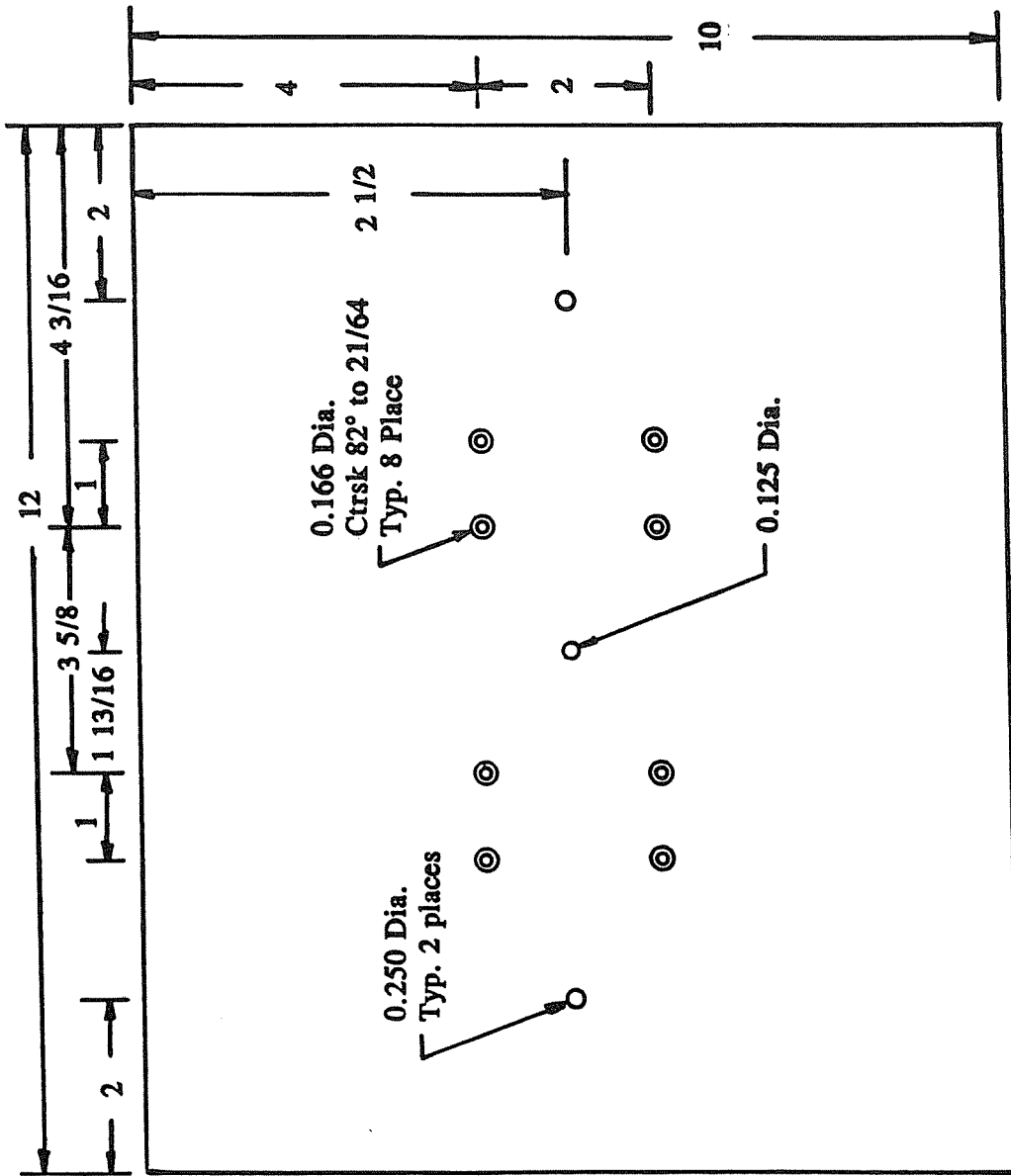

Material - 3/8 Yorolite G11

Tolerance: XXX ± .005
 XX ± .010
 X ± .015
 X/X ± 1/32

Note: Features and locations may not all be to scale.
 All dimensions are in inches.
 Pilot holes for sheet metal screws
 will be drilled as required to mount
 ice point compensator and
 instrumentation amplifier.

Mounting Plate

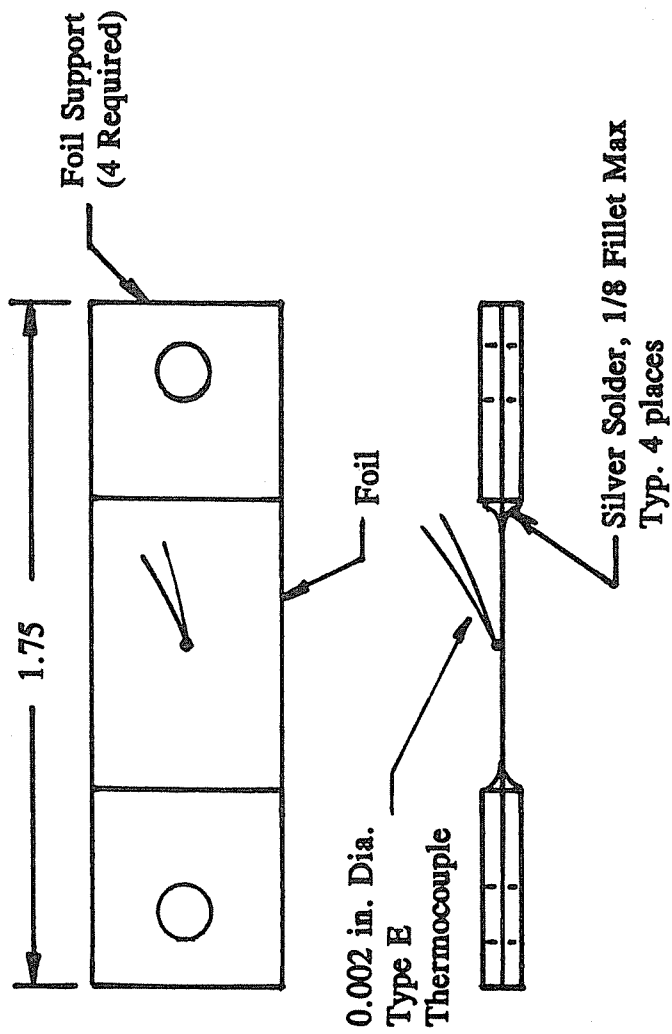

Solder with Silver Brazing Alloy
50% Ag, 15.5% Cu, 15.5% ZN, 16% Cd, 3% N
MP/FP, 1170°/1270°F

Spot weld thermocouple in center
of foil as described in Para. 3.0.

Foil Assembly

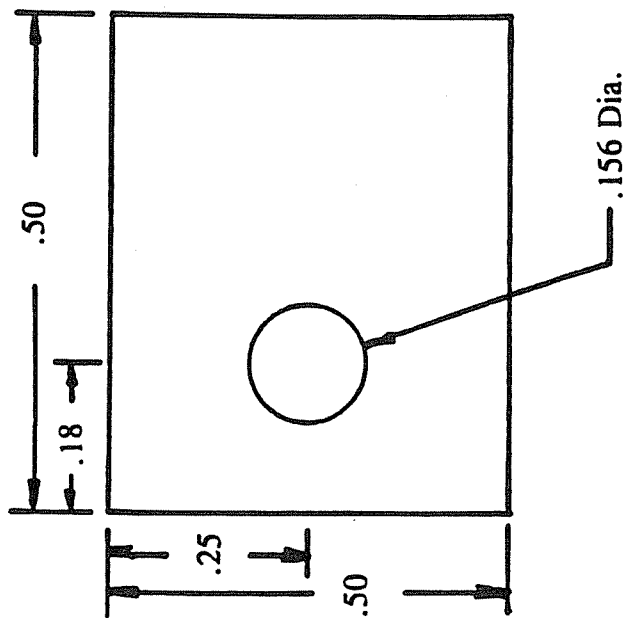

Material - 0.64 x 1/2 Brass Sheet Stock

Tolerance: XXX $\pm .005$ Note: Features and locations may not all be to scale.
 XX $\pm .010$ All dimensions are in inches.
 X $\pm .015$
 X/X $\pm 1/64$

Support, Foil

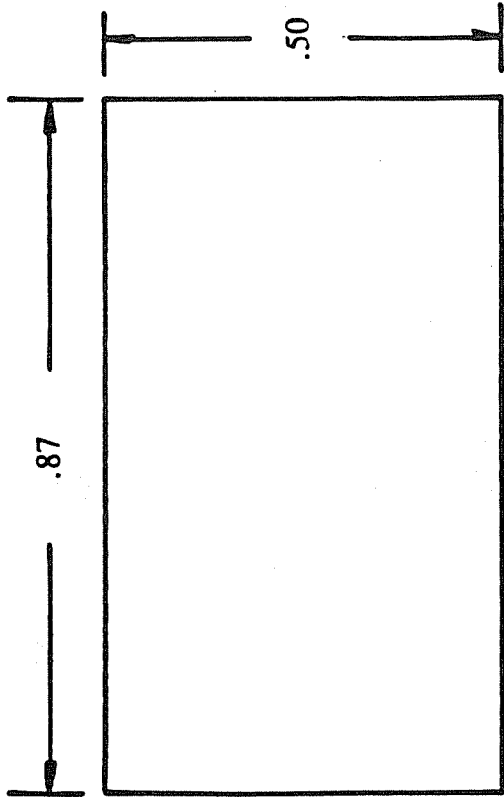

Material - Stainless Steel 302 Skin Stock
 .006 Thick

Tolerance: XXX ± .005 Note: Features and locations may not all be to scale.
 XX ± .010
 X ± .015 All dimensions are in inches.
 X/X ± 1/64

Foil

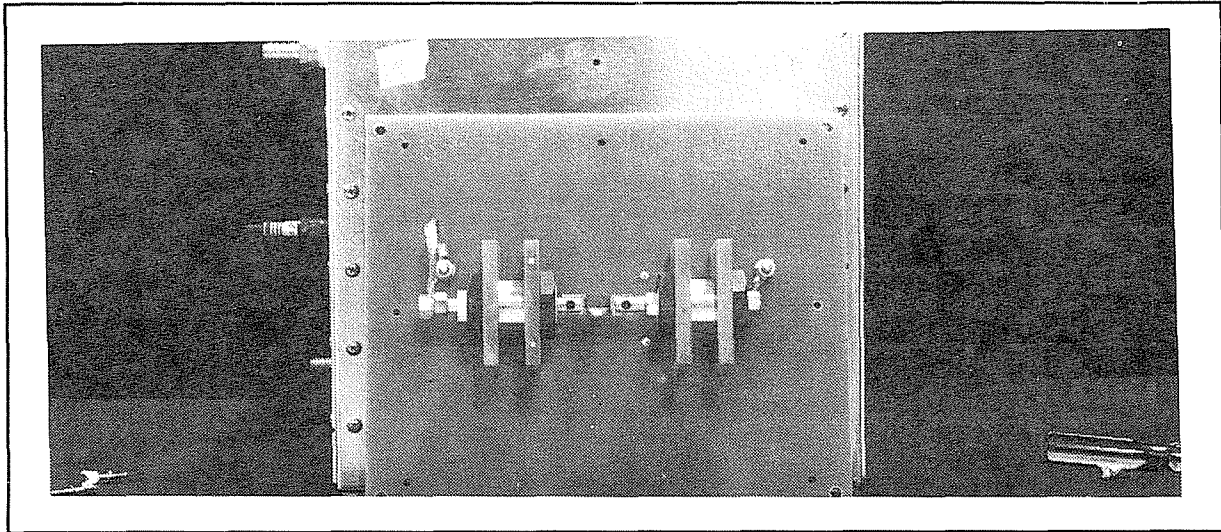

Front View

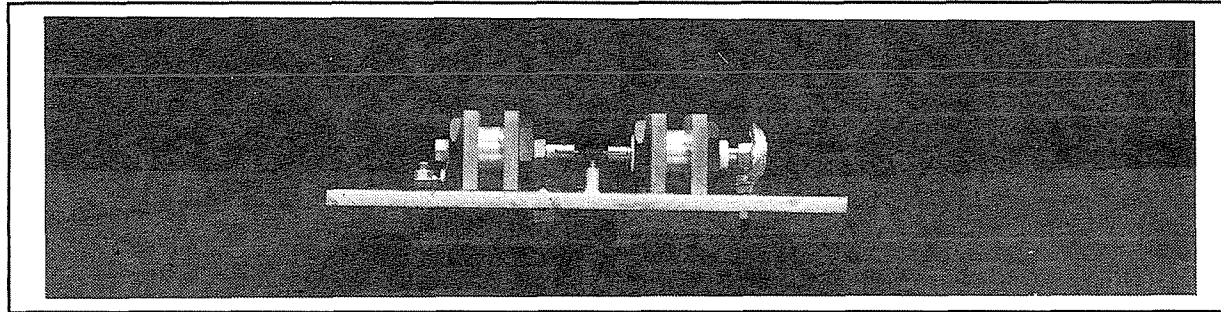

Top View

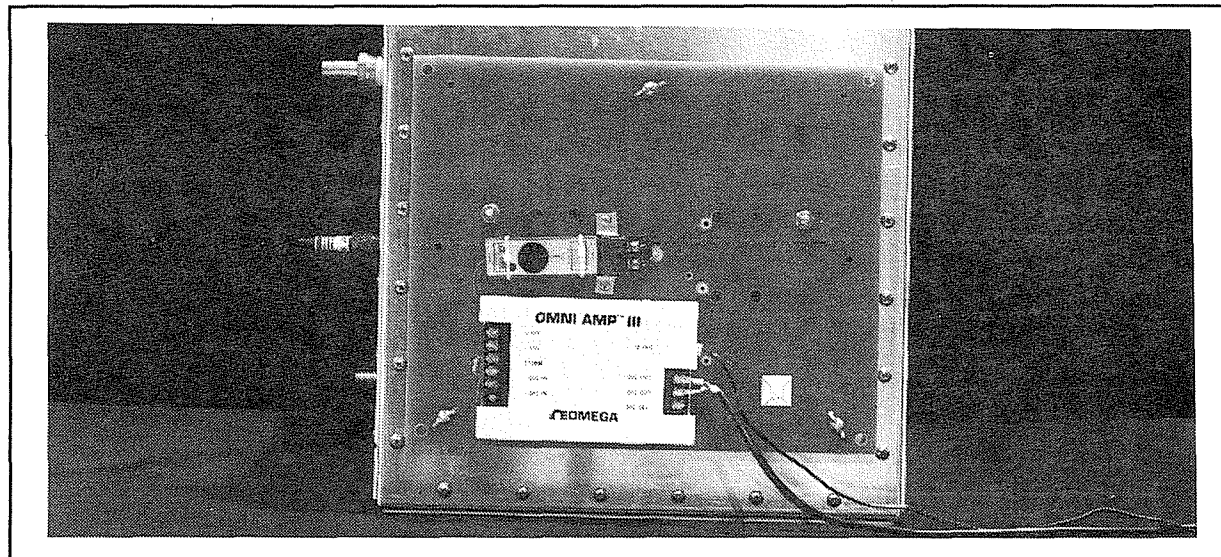

Rear View

Source Module, Front and Rear Views

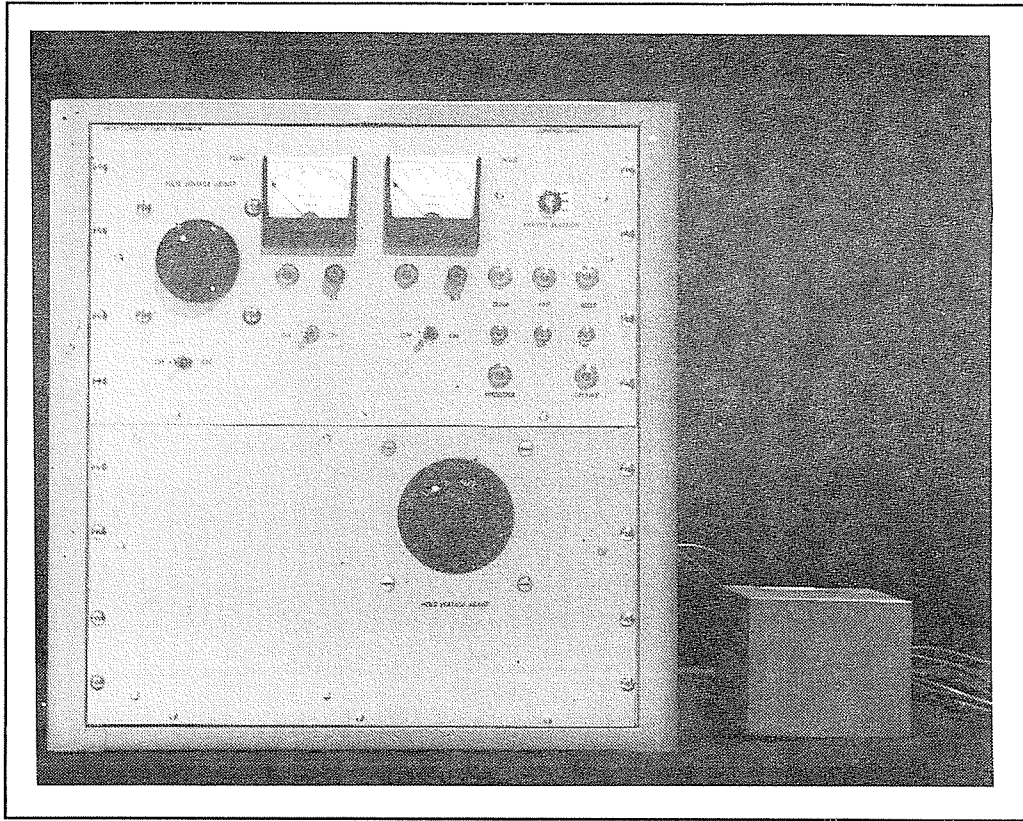

Front View

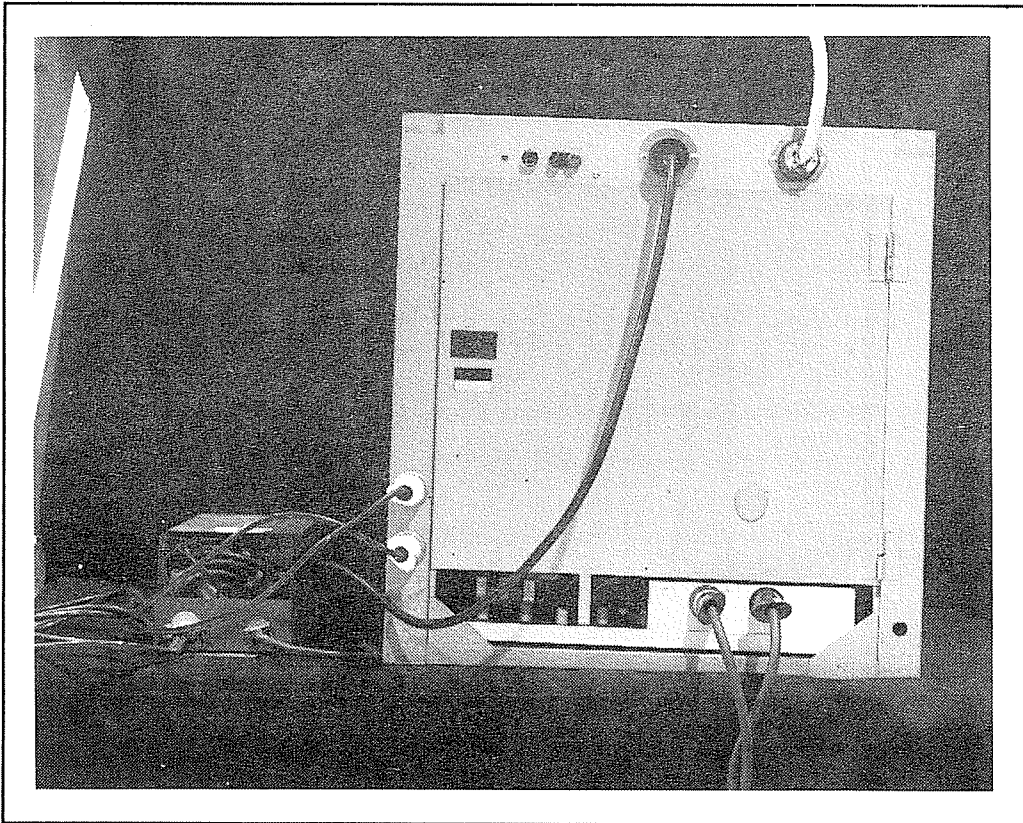

Rear View

Control Module, Front and Rear Views

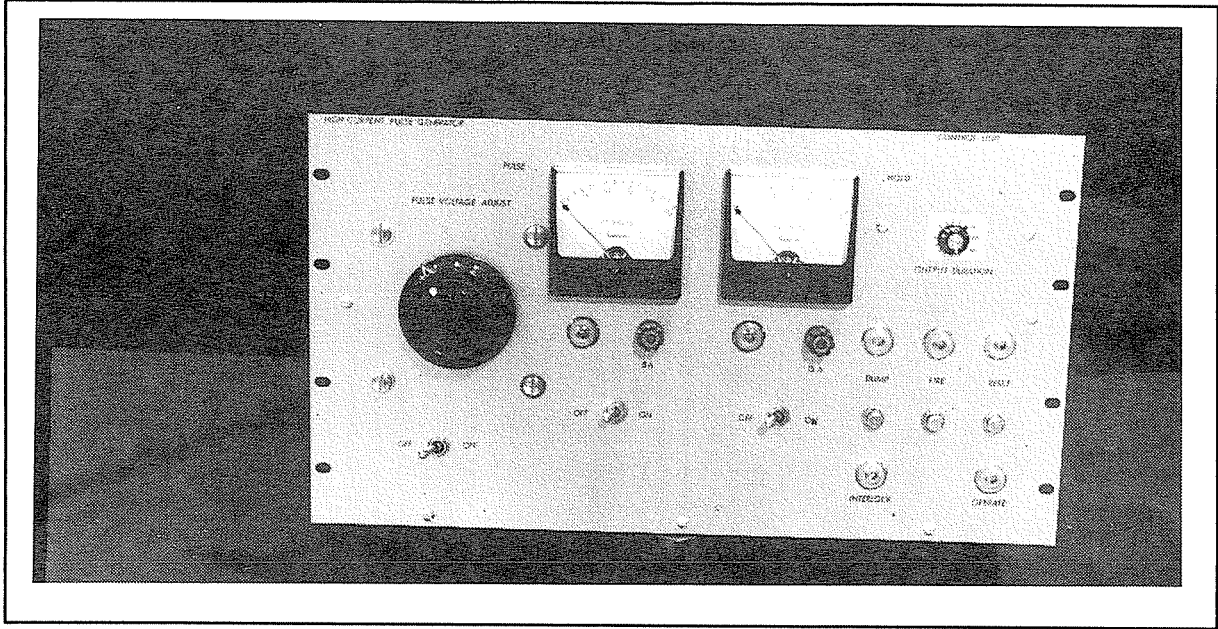

Front View

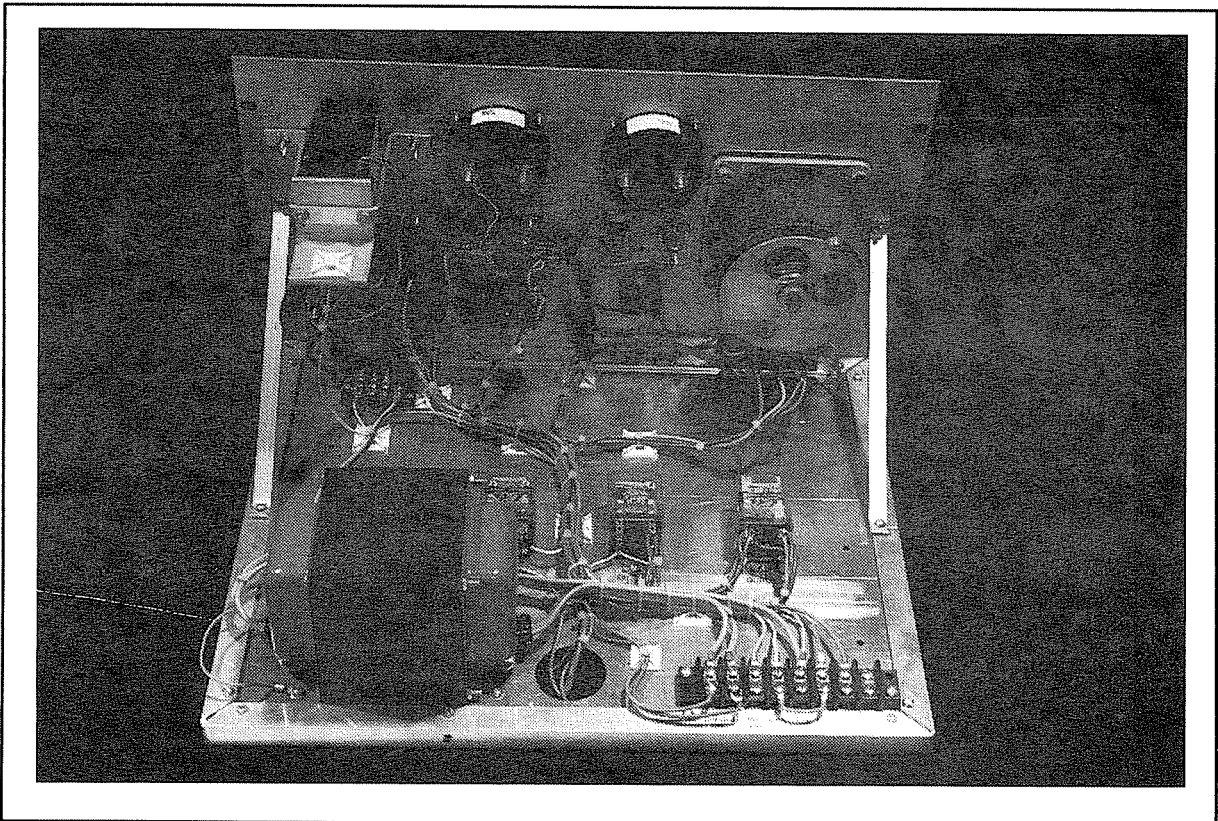

Rear View

Control Module, Upper Shelf
(removed from cabinet)

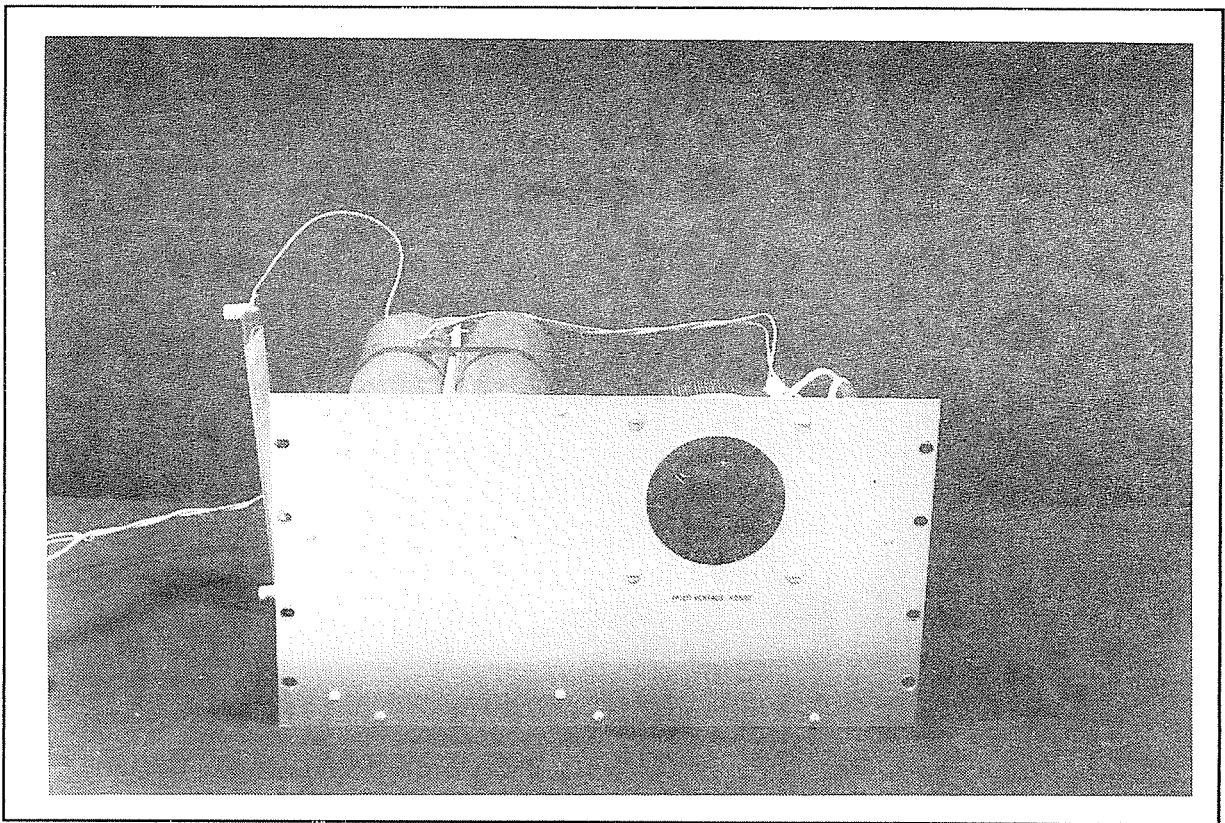

Front View

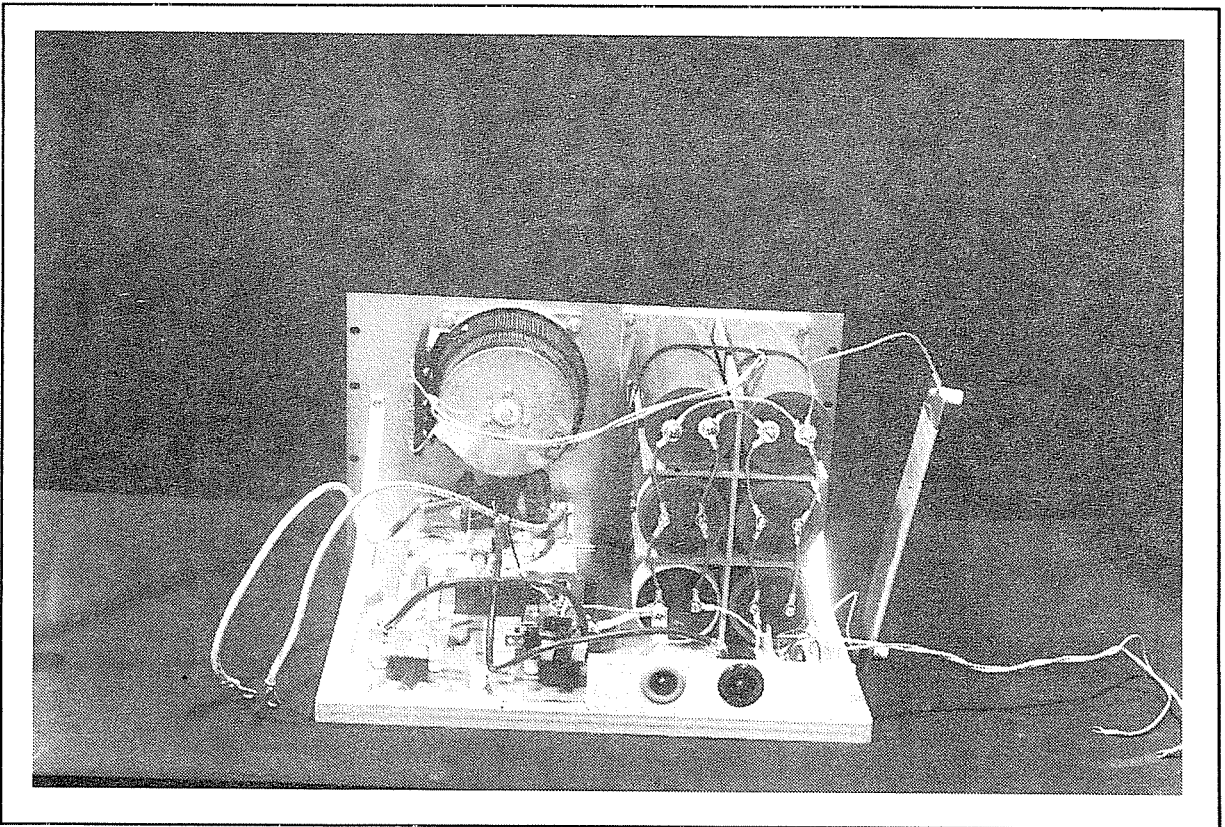

Rear View

**Control Module, Lower Shelf
(removed from cabinet)**

6.0 REFERENCES

1. Laurendeau, N. M., Caron, R. N., *Influence of Hot Surface on Methane-Air Ignition Temperature*, Combustion and Flame, Volume 46, p. 213, 1982.
2. Demetri, Elia P., White, Bruce F., *Development of a Model for Hot-Surface Ignition of Combustible Liquids*, Advanced Mechanical Technology, Inc., Newton, MA for Air Force Wright Aeronautical Laboratories, WPAFB, OH, Contract No. F33615-83-C-2380, May 1984.
3. Crouch, K. E., *Aircraft Fuel System Lightning Protection Design and Qualification Test Procedures Development Investigation of Fuel Ignition Sources*, Naval Air Development Center, Report No. NADC-86100-20, August 1986.

APPENDIX D

LT-94-1032

AIRCRAFT FUEL SYSTEM LIGHTNING PROTECTION DESIGN

AND

QUALIFICATION TEST PROCEDURES DEVELOPMENT

Photographic Ignition Detection Techniques

Prepared by:

John E. Pryzby

Approved by:

J. Anderson Plumer

For

Federal Aviation Administration
FAA Technical Center
Atlantic City Int'l Airport, NJ 08405

Contract No. DTFA03-92-C-00003

LTI Project No. 1074

February 1994

Lightning Technologies, Inc.
10 Downing Parkway
Pittsfield, MA 01201
U.S.A.

1. Report No.		2. Government Accession No.		3. Recipient's Catalog No.	
4. Title and Subtitle Aircraft Fuel System Lightning Protection Design and Qualification Test Procedures Development: Photographic Ignition Detection Techniques				5. Report Date February 1994 Revised April 1994	
				6. Performing Organization Code	
7. Author(s) John E. Pryzby				8. Performing Organization Report No. LT-94-1032 Revision A	
9. Performing Organization Name and Address Lightning Technologies, Inc. 10 Downing Parkway Pittsfield, MA 01201				10. Work Unit No. (TRAI) DTFA03-92-C-00003	
				11. Contract or Grant No.	
12. Sponsoring Agency Name and Address DOT/FAA FAA Technical Center Atlantic City Int'l Airport, NY 08405				13. Type of Report and Period Covered Interim Report	
				14. Sponsoring Agency Code	
15. Supplementary Notes					
16. Abstract Background information is provided on the use of the photographic technique to detect potential fuel ignition sources. The strengths and weaknesses of this detection method are presented. Test data and a discussion are given on the ability of photographic methods to detect voltage spark and hot spot ignition sources and quantify the probabilities of ignition. The basic test steps to be followed for photographic detection of ignition sources are listed.					
17. Key Words Lightning Fuels Testing Qualification Design			18. Distribution Statement		
19. Security Classif. (of this report) Unclassified		20. Security Classif. (of this page) Unclassified		21. No. of Pages 17	22. Price

AIRCRAFT FUEL SYSTEM LIGHTNING PROTECTION DESIGN

AND

QUALIFICATION TEST PROCEDURES DEVELOPMENT

Photographic Ignition Detection Techniques

ISSUE AND APPROVAL RECORD

Rev	By	Date	Revision Approved by	Pages Revised or Added
A	J.E. Pryzby	6 April 1994	<i>JEC</i>	Added background material and validation testing; added figure to component testing section; expanded information in basic test procedure list.

TABLE OF CONTENTS

SECTION	PAGE NO.
Executive Summary	iii
Photographic Ignition Detection Technique	1
Background	1
Photographic Technique Validation Tests	2
Standard Voltage Spark Ignition Source Tests	2
Background	2
Results	3
Standard Hot Spot Ignition Source Tests	7
Background	7
Results	10
Discussion	10
Application of the Photographic Technique	12
Component Testing	12
Full System Tests	15
Equipment	15
Interpretation of Results	16
Hot Spots	16
Voltage Sparks	16

EXECUTIVE SUMMARY

An evaluation of the photographic ignition detection technique found that the ability of the technique to discern between ignition sources and non-ignition sources depends heavily on a knowledge of the type of source being observed. When the type of source is known, then data on image density could provide estimates of the ignition probability. Since in many cases the type of ignition source will not be known, the best use of the photographic technique will be in identifying potential ignition sources which must be further evaluated.

A description of the technique, its background and method of application is provided. Data obtained from standard spark and hot spot source tests is presented. Discussions of strengths and weaknesses are included.

PHOTOGRAPHIC IGNITION DETECTION TECHNIQUE

Background

The original technique described in the test documents (SAE AE4L Blue Book, MIL-STD-1757A, AC 20-53A) utilized Polaroid photography to detect and record "sparks".

In practice, because of space limitations found in many fuel tanks, particularly near the wing tip area, 35 mm cameras were substituted for Polaroid cameras. Film speeds and lens apertures were adjusted to provide the same light sensitivity as prescribed, i.e. a Polaroid camera equipped with an f/4.7 lens and loaded with ASA 3000 film.

Photographic detection offers some strengths as an ignition detection technique. Equipment is readily available, and operation is straightforward. If an ignition source exists, as indicated by light on the test film, comparison of the test photograph with a previously taken "background" photograph would reveal the location of the ignition source. The resulting 35 mm negatives can be enlarged for further evaluation and for publication in a test report.

Photographic detection has some inherent weaknesses. Experience has shown that low energy voltage sparks of 200 microjoules are barely detectable by Polaroid cameras with ASA 3000 film. In some cases, Polaroid film imperfections can mimic low energy sparks. Theoretical calculations by Anderson (Ref. 1) relating the area and charge of a spark with camera f stop setting showed that ASA 3000 film with an f/4.7 lens is marginally capable of detecting 200 microjoule sparks.

Areas not within the camera's field of view may contain ignition sources which can go undetected. Mirrors have been used to observe camera "blind" spots, but mirror images are more difficult to analyze due to the smaller image of the light source caused by additional distance to the image and also due to the possibility of reflections.

Problems also occur when the test article can transmit ambient light. This occurs when some of the material used in the part is translucent. When ambient light is recorded on the test film, it is not possible to insure that ignition sources have not been masked. And finally, detection of an ignition source by photographic film gives no indication of the probability of ignition represented by the recorded image.

Four foot long test chambers are commonly used for testing fuel system parts and panels. The minimum focussing distance of Polaroid cameras on the market is

Ref. 1 Crouch, K. E. and Robb, J. D., "Aircraft Fuel System Lightning Protection Design and Qualification Test Procedures Development" NADC Report No. NADC-85090-20, February 1985, Appendix 3, p. 25.

approximately 3.5 feet. Theoretical calculations by Anderson (Ref. 2) show that film exposure for close objects is not governed by the distance of the light source from the lens, but by spherical lens aberrations, particularly the circle of confusion of the lens. The limitation imposed by a circle of confusion of 0.0003 inches was calculated to be about 6.8 feet for a 50 mm lens. This distance is greater than the four foot length of the test chamber used in this program, and is greater than the distance typically found to occur between potential ignition sources in fuel tanks and the positions at which 35 mm cameras can be located.

PHOTOGRAPHIC TECHNIQUE VALIDATION TESTS

The ability to quantify ignition probabilities through photographic detection was evaluated during experiments using the Standard Voltage Spark Ignition Source (SVSIS) and Standard Hot Spot Ignition Source (SHSIS). The source module was fastened to one end of a four foot long light-tight test chamber with Polaroid and 35 mm cameras positioned at the opposite end.

Standard Voltage Spark Ignition Source Tests

Background

Evaluation of voltage sparks utilized the SVSIS at various energy levels. As spark energy was increased, additional silver halides held in the 35 mm film emulsion were converted to free silver thus increasing the size of the recorded image. By compiling a table of spark energy vs. film image area, it was possible to produce a calibration curve. Film image areas were determined by using a 50X microscope with a scribed reticle.

Films were chosen based on general availability. Some films, such as those sensitive to UV, are available only on a special order basis from scientific or industrial photographic houses and may require the use of non-35 mm format equipment. Infrared film was available in black and white and color transparency emulsions. The black and white version was chosen due to its general availability.

The first group of tests was performed with two black and white films: Kodak 2481 High Speed Infrared and Kodak TMAX P3200 high speed films.

The infrared film, which has an approximate film sensitivity rating of ASA 25-80, was tested to evaluate whether the SVSIS emitted radiation which could be detected by an infrared-sensitive film. A type 87 filter was attached to the camera lens to absorb most or all of the ultraviolet and visible radiation to which the film is also sensitive.

Ref. 2 Ibid., Appendix 3, p. 19.

Note: Photographic materials can be sensitized to provide a spectral response from 250 to 1200 nm. Infrared film 2481 is sensitive through the visible region of the spectrum and into the infrared region to approximately 900 nm, with maximum IR sensitivity from 700 to 880 nm.

P3200 is a high speed black and white film whose light sensitivity (ASA value) can be varied by a change in development processing time. For the purpose of the first test series, the P3200 film was exposed and developed to an ASA of 3200 which corresponds to the sensitivity of Polaroid film which was also exposed for these tests. The 35mm lens apertures were set to f/2.8 and the Polaroid camera lens was set to f/4.7. Note: The f/4.7 lens aperture represents the largest aperture setting possible on the Polaroid camera.

Spark energies were determined by recording capacitance and supply voltage at the time of flashover. The initial applied energy level was 200 microjoules. The energy level for each subsequent test was approximately 55 microjoules higher which was the increase obtained by turning the variable capacitor of the SVSIS one 360 degree turn. Testing ended when the energy level reached 750 microjoules.

A second test series was performed with the two 35 mm cameras loaded with high speed black and white and color films. The films were Kodak P3200 black and white film and Kodak Ektapress Gold 1600 color film. Lens apertures for both cameras were set to f/2.8. The films were developed to an ASA of 1600 since films of this rating are commonly found in most photographic outlets compared to films rated at ASA 3200 which are harder to find. A Polaroid camera, loaded with Polaroid Type 667, ASA 3000 film was also used. Its lens aperture was set to f/4.7.

Results

Testing was initiated at the 200 microjoule level. The first test series was terminated at an energy level of 750 microjoules. The second test series proceeded to the limit of the variable capacitor which represented an energy level of approximately 1 millijoule for the 2 mm spark gap.

Following both test series, the films were developed and the negatives examined with a microscope as described above.

No images were recorded on the infrared film for any of the tested energy levels. Since there was no indication of an image on any of the film frames, there was no reason to redo the tests at any other lens aperture. For the purpose of voltage spark detection, the use of black and white infrared film provided no information.

Images were recorded on the high speed P3200 black and white film and the Ektapress Gold 1600 color film at all energy levels. The results of the two test series are shown in Tables 1 and 2 along with probability of ignition obtained from previous studies for the Naval Air Development Center (Ref. 3).

The data from Table 2 is plotted in Figure 1. The graph shows that film image area increased as the ignition probability (and energy level) increased.

Examination of the films showed that sparks representing ignition probabilities up to 40% could easily be missed without close examination of the test negative, especially if they were photographed on Ektapress 1600 color film. Energy levels representing ignition probabilities greater than 40% are easier to discern by the naked eye. The graphs show that image area increased the most on the P3200 black and white film making this film a better choice for low level voltage spark detection.

Granularity and resolution data for the P3200 black and white and Ektapress 1600 color films are as follows:

<u>Film</u>	<u>Granularity</u>	<u>Resolution (Low contrast)</u>	<u>(high contrast)</u>
P3200 b&w	18-fine	40 lines/mm	125 lines/mm
1600 color	11-very fine	40 lines/mm	80 lines/mm

Note: The number listed under Granularity is an indication of grain size.

The information above indicates that the P3200 black and white film has a larger grain size than the 1600 color film. This would indicate that as the P3200 film receives more exposure (higher spark energy levels), the sensitized grains would cover a larger area than the corresponding smaller-grained color film. Thus the image area on the P3200 black and white film increased to a greater extent and was easier to detect than the image on the 1600 color film. Also, at high contrast levels, the P3200 black and white film is also sharper than the 1600 color film making it easier to calculate image size.

In order to evaluate the ability of the photographic method to determine spark energies, one person randomly set the SVSIS energy levels while a second person photographed the resulting voltage sparks. Films used for the evaluation included 35 mm black and white (ASA 3200), 35 mm color (ASA 3200), and Polaroid (ASA 20,000).

Ref. 3 Crouch, K.E., *Aircraft Fuel System Lightning Protection Design and Qualification Test Procedures Development - Investigation of Fuel Ignition Sources*, NADC-86100-20, August 1986, p. 5-23.

Table 1 - ASA 3200 Black & White Film

Spark Energy (microjoules)	Image Area (sq mm)	Probability of Ignition (percent)
205	0.008	0
260	0.020	0
315	0.022	0
375	0.023	0
420	0.036	0
465	0.070	0
545	0.060	1
575	0.073	3
595	0.088	5
750	0.094	40

Note: Probabilities shown as zero percent represent an actual probability of less than 0.01 percent.

Table 2 - ASA 1600 Black & White and Color Films

Spark Energy (microjoules)	Image Area B&W Film (sq mm)	Image Area Color Film (sq mm)	Probability of Ignition (percent)
195	0.006	0.003	0
245	0.006	0.003	0
290	0.006	0.003	0
340	0.011	0.005	0
380	0.020	0.006	0
495	0.032	0.006	0
500	0.025	0.006	0
530	0.039	0.006	1
550	0.059	0.009	1
565	0.075	0.012	2
770	0.066	0.012	43
795	0.068	0.008	54
810	0.071	0.016	58
870	0.075	0.012	73
875	0.075	0.019	78
900	0.075	0.014	82
915	0.075	0.011	86
1055	0.105	0.013	97

Note: Probabilities shown as zero percent represent an actual probability of less than 0.01 percent.

Once the films were developed, they were evaluated for spark energy by the second person using a calibration curve similar to Figure 1. The second person had no knowledge of the spark energies used during the test. A comparison of the applied spark energies with the estimated energies determined with the aid of the calibration curve gave an indication of the ability of the photographic technique to determine ignition probabilities. Note: Polaroid evaluations were made by comparing the Polaroid photographs obtained with those taken previously during an earlier calibration test series.

The graph of Figure 2 shows the estimated energy levels in bar graph form and the actual energy levels as markers. The results indicated that the estimated energy levels were lower than the actual levels. Estimates based on the Polaroid photographs were in error by 20%-40% and represented the best estimates of the three films tested. The second best results were obtained with the black and white film where the percentage error ranged from 20% to 60%. The color film error ranged from 5% to 100%.

The results shown in Figure 2 indicate that evaluation of voltage spark ignition probabilities through photographic detection is not reliable. Even with a known spark source of fixed physical parameters and location, the best estimate of ignition probability was in error by 20%. Photographs of voltage sparks in an actual test situation would be more difficult to analyze. Variables would include not only the spark energy, but also the gap separation dimension and the distance of the spark source from the camera lens.

Standard Hot Spot Ignition Source Tests

Background

Hot spot ignition sources were evaluated using three different 35 mm films in conjunction with the Standard Hot Spot Ignition Source. They were color and black and white negative films rated at ASA 1600 and black and white infrared film.

Objects at temperatures below 500°C will not emit radiation in the wavelengths which can be recorded by conventional films. At temperatures above 500°C, objects become self-luminous and can be photographed without any other source of illumination. However, with infrared sensitive film, an object at temperatures between 250 and 500°C emits enough actinic energy to produce an image on film. Thus, this film is capable of recording a wider range of temperatures than conventional films.

These tests are based on two premises: (1) For a given surface, radiation increases with temperature; and (2) the greater the amount of radiation striking the film, the greater the image density produced. Thus, equal image densities on the 35 mm negative would indicate equal hot spot temperatures.

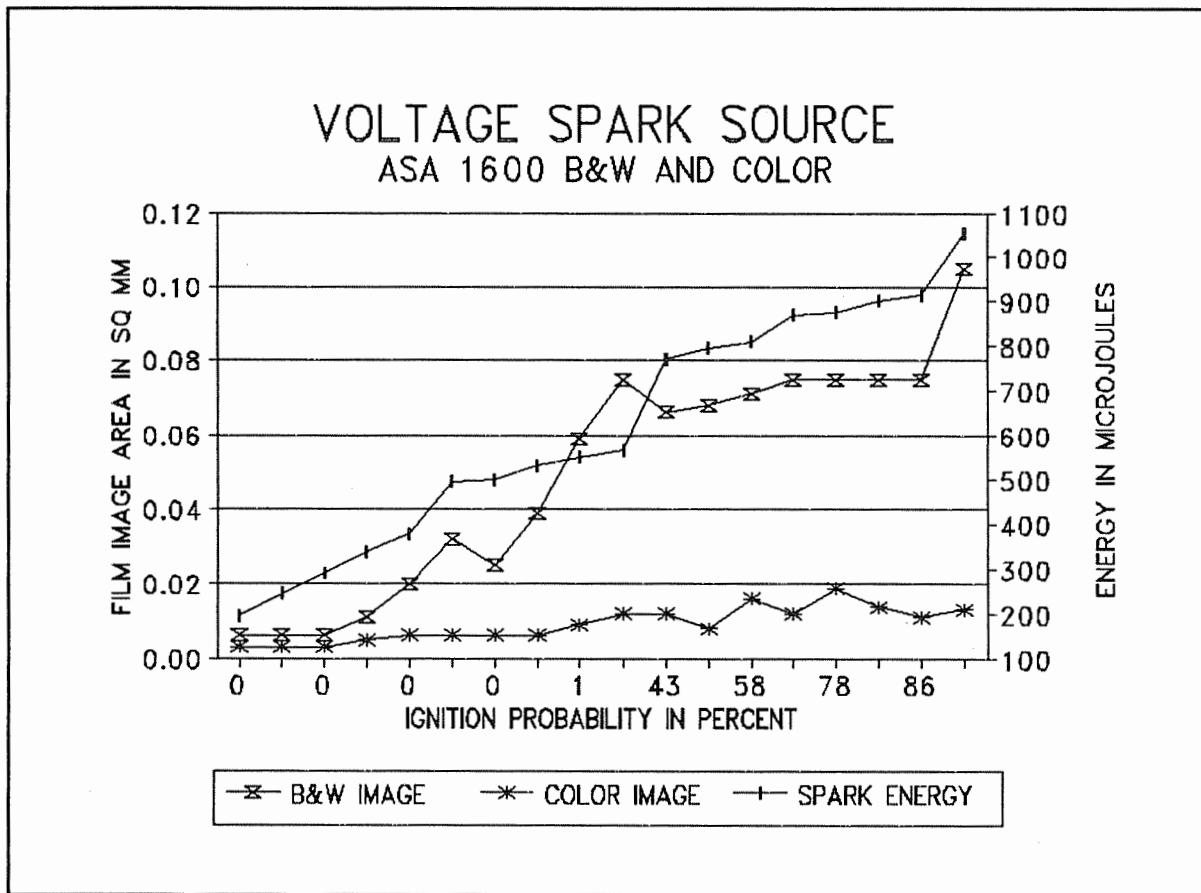

Figure 1 - Film Image Area and Spark Energy vs. Ignition Probability for ASA 1600 Black & White and Color Films (0 = less than 0.01% probability)

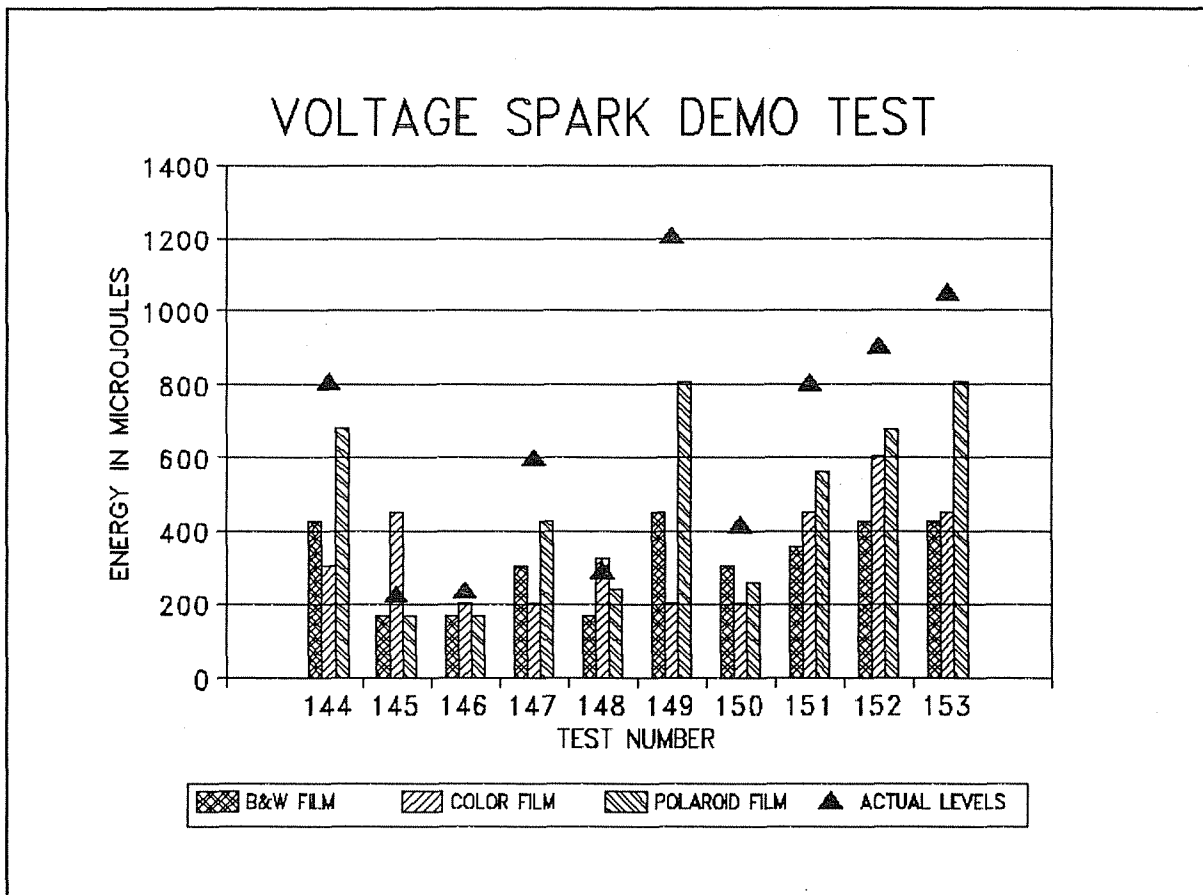

Figure 2 - Photographic Detection of Voltage Sparks, Demonstration Test

Results

Tests were performed with the SHSIS set to produce two distinct temperatures, one which would not ignite fuel, and the second which would always ignite fuel. Since the density of the photographic image was a measure of the hot spot temperature, the resulting image densities were measured by a photographic densitometer and tabulated. Tests were performed at camera f stop settings ranging from f/2.8 through f/16. The results are shown in Figure 3.

The graph shows that the best data was obtained with the infrared film. At a camera setting of f/2.8, the density difference between a hot spot producing ignition and one not producing an ignition was approximately 3.5:1. The density difference produced by the conventional black and white film was almost 2:1. The color film readings were nearly identical, making them unusable in determining hot spot temperatures.

As the camera f stop setting was changed toward smaller apertures (higher numbers), the difference between ignitable and non-ignitable hot spots became less pronounced. This makes sense since the largest aperture (f/2.8) allows the greatest amount of light to pass through the camera lens to the film.

The most accurate data was obtained at a lens opening of f/2.8. At the smaller apertures, the image area on the film became too small to accurately measure with a densitometer. Some of the densities recorded for this test are somewhat inaccurate since the densitometer measured a portion of the background surrounding the hot spot area.

Discussion

The optical detection validation tests show that photography can be used to detect voltage sparks and hot spots. The ability to quantify the probability of ignition from either of these sources, however, has not been shown to be possible with any degree of reliability.

Photography can continue to be used as an ignition source detector if the probability of ignition is not desired. The ability to detect low energy 200 microjoule sparks can be improved by the use of faster lenses or higher speed film. The tests performed for this program concentrated on lens aperture settings of f/2.8, but most 50 mm lenses available today have maximum apertures of f/2 or better. In addition, black and white 35 mm film such as Kodak's P3200 film can be developed to higher ASA ratings than tested here, such as ASA 12,000. Polaroid cameras are limited to maximum lens apertures of f/4.7. However, black and white Polaroid film is available at an ASA rating of 20,000 which will improve the image intensity of a 200 microjoule spark.

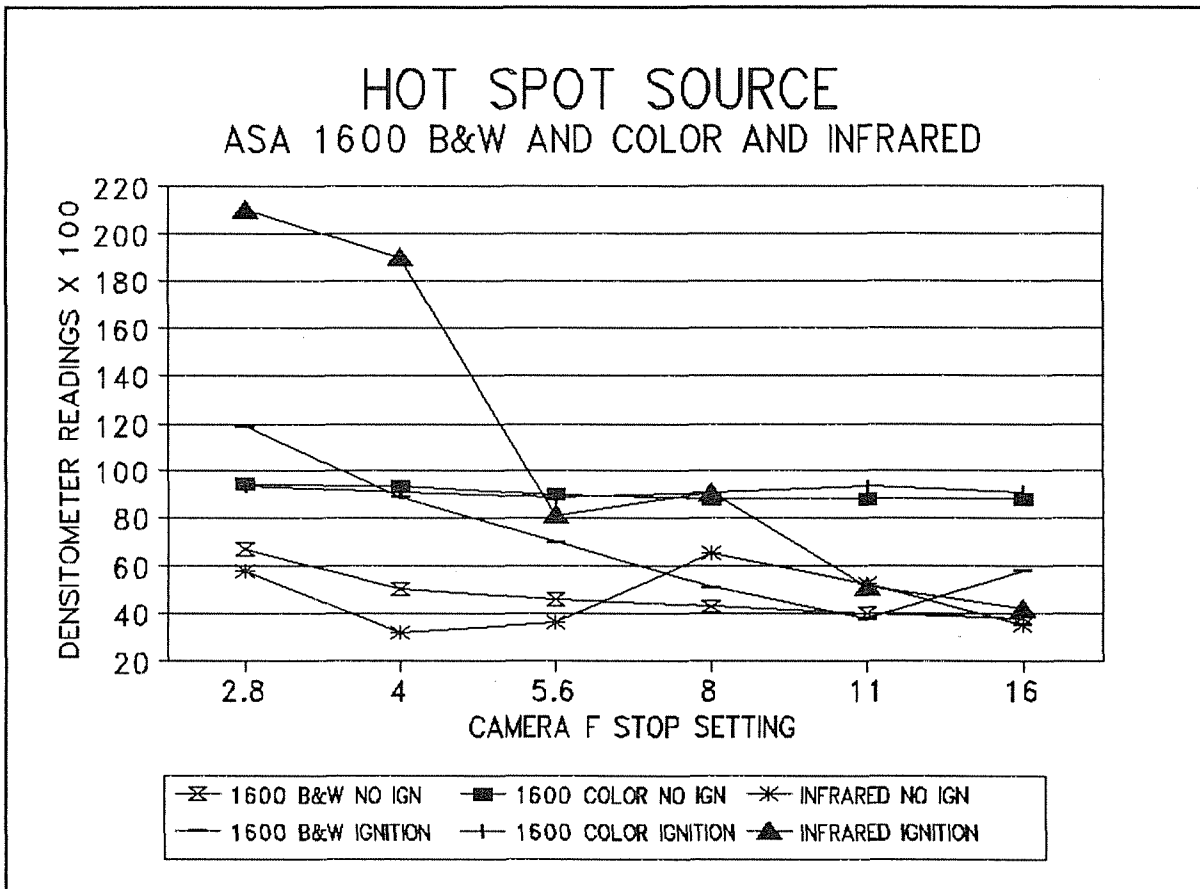

Figure 3 - Hot Spot Source Test Results

Optical detectors which include photomultiplier tubes and image intensifiers were not evaluated. Photomultiplier tubes are quite sensitive and have good spectral sensitivity in the range of interest. However, although they can sense light, they cannot indicate the exact location of the source. They are also subject to external electromagnetic fields and cannot be exposed to high intensity ultraviolet radiation from sources such as fluorescent room lights. A high energy spark can damage the tube if it had been set up to detect minimum energy sparks.

Image intensifiers are similar to photomultiplier tubes in having a high sensitivity to light, but they also produce an actual image. These devices also suffer the disadvantage in that they are subject to electromagnetic effects. Their cost and the care they require are additional disadvantages.

APPLICATION OF THE PHOTOGRAPHIC TECHNIQUE

Detection of ignition sources through the use of photography is one of the methods of assessing the possibility of a fuel ignition hazard from lightning current flow. The photographic method depends on the ability of cameras to view all areas of a fuel system where ignition hazards may exist. This technique also cannot be used if the part to be tested is translucent or can transmit light in any way that might mask arcing or sparking. If potential ignition source areas are blocked from view, it may be necessary to perform the tests using the combustible vapors technique.

Photographic detection can be used on individual fuel system components or on full systems. Individual component tests are performed using a darkened test chamber. The component to be tested is positioned at one end of the chamber with the test cameras at the opposite end. The camera lenses view all of the critical component areas under test. Full system tests are performed with the cameras placed in the system with their lenses focussed on potential ignition hazard areas.

Component Testing

Components such as fuel filler caps, tank skins, fasteners, and plumbing interfaces with structure can be attached to the end of the chamber as a test panel. Vent lines, fuel probes, and fuel line couplings can be mounted inside the chamber with test currents conducted through the component. Test leads are attached to the component in a manner which prevents arcing at the connections from being recorded by the cameras.

The chamber should be fitted with a fiber optic light tube system. This arrangement allows a "spot" of light to be recorded on the test photographs for reference purposes should a potential ignition source be photographed. See Figure 4.

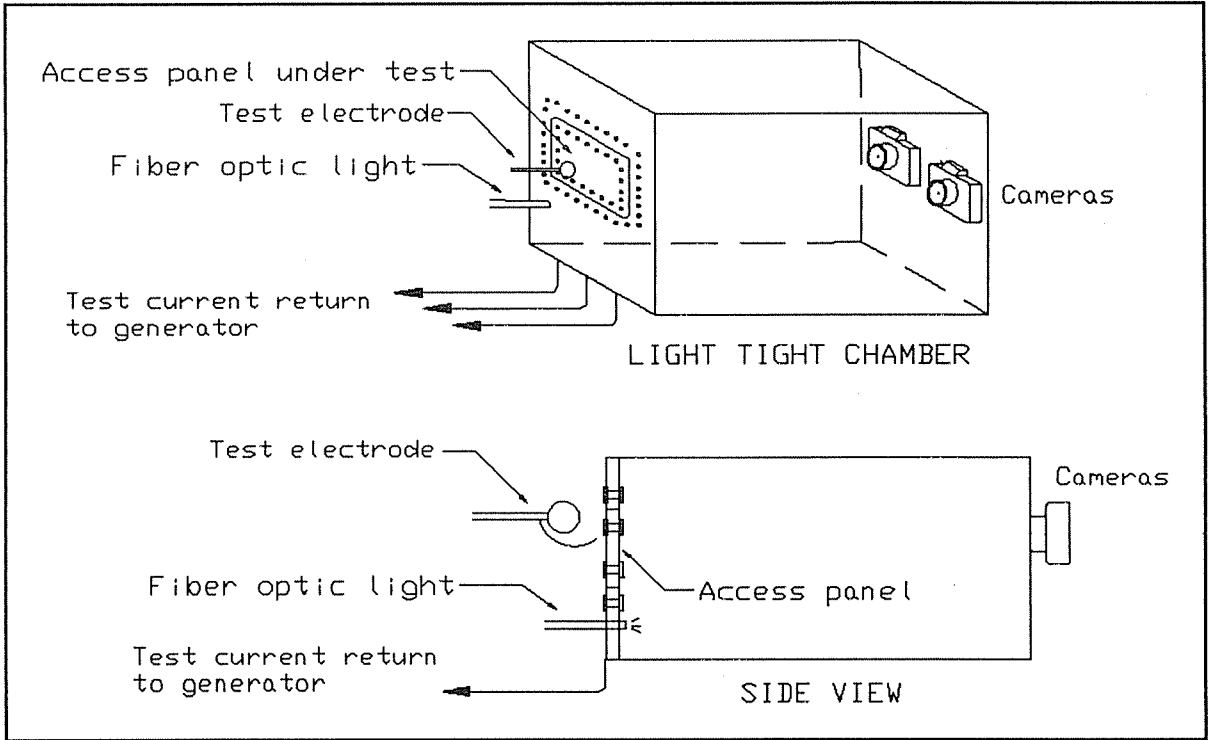

Figure 4 - Laboratory Setup for Component Testing

Test setup requirements are described for direct effects, structural damage tests (and indirect voltage tests for those cases where sparks in electrical equipment may result). For guidance, see the test procedures documents (ie. SAE AE4L Report, Mil-Std-1757, AC 20-53). The basic test procedure is:

- a. Install the fuel system component/panel at one end of the test chamber. Position a fiber optic reference light adjacent to the test article so that it will be included in the test photographs.
- b. Connect test leads from the component or panel to generator return.
- c. Load a Polaroid camera with ASA 3000 Polaroid film. Load one or more 35 mm cameras with ASA 1600 black & white or color film. (Note: Black and white film images show greater density variations than color film as a function of spark energy. Therefore, it is easier to relate spark energy to film density with black and white film than with color film.)

If hot spot tests are to be performed, one camera should be loaded with black and white infrared film. If it is desired to detect 200 μ J voltage sparks, it is advisable to use higher speed films. Polaroid film rated at ASA 20,000 and 35 mm film rated at ASA 3200 and higher are available.

- d. Install cameras at the chamber end opposite the location of the test article. Set the Polaroid camera lens to f/4.7 and the 35 mm lens(es) to f/2.8. If it is required to detect 200 μ J voltage sparks, a 35 mm aperture setting of f/2 will increase the image density for easier detection.
- e. Take background photographs with all cameras. For greater clarity, it is helpful to set the lens apertures to f/16. After the background photos have been taken, be sure to reset the lens apertures for the test.
- f. Seal the chamber and lock the Polaroid camera shutter open. Shine a light around the component end of the chamber for several minutes. Close the Polaroid lens and extract the film for development.
- g. Check the Polaroid photograph to see if there are any light leaks in the chamber. If there are, repeat steps f and g until all light leaks have been sealed.
- h. Seal the test chamber, lock open the camera lenses, and perform the high current test on the component.
- i. After the high current discharge, momentarily turn the fiber optic light on to place a spot of light on the test film. Close the camera shutters.

- j. Pull the Polaroid film and examine the results. Advance the 35 mm cameras to the next frame.
- k. If light has been recorded, compare the test photograph with the "background" photograph to determine the source of the light.
- l. At the conclusion of the test series, remove the 35 mm films for development. Compare the developed 35 mm films with the Polaroid results.

Full System Tests

The procedure for full size fuel tank testing is the same as for component testing with a few exceptions. Space constraints within most fuel tanks will preclude the use of Polaroid cameras. In order to minimize the number of tests to be performed, several 35 mm cameras should be used when possible. Close-focussing wide angle lenses are recommended to provide the greatest possible area of coverage for each camera. Each camera should be carefully positioned and held in proper orientation by the use of non-conductive supports.

Due to the close quarters within the tank and the number of camera locations for each test, it is not practical to use fiber optic light tubes as described above. Some locations may require the use of mirrors to reflect the light from potential ignition sources to the camera lenses.

Equipment

The following is a list of suggested equipment and supplies which are needed to conduct the ignition evaluations. Other equivalent equipment can be substituted by the test laboratory.

Films

Kodak T-Max P3200 TMZ 135-36 (Developed to ASA 1600)
Fuji Super HG 1600 CU 135-24
Polaroid Type 667 ASA 3000

Cameras

Ricoh 35mm XR-10 SLR w/50 mm f/2.0 lens
Polaroid 600SE w/f/4.7 lens

Test Chamber

The test chamber for component tests should be constructed of an opaque, electrically-insulating material such as G-10 fiberglass. The walls can be painted with black paint, inside and out, to darken the interior. A provision for mounting the cameras to the outside of one end will allow viewing during set-up of the test.

The dimensions of the chamber must be sufficient to accommodate anticipated fuel system components. A 2 ft. x 2 ft. x 4 ft. chamber has been found to be adequate for most testing. If it is desired to use the chamber for combustible vapor testing as well, then adequate blow-out openings and a sealed glass barrier between the fuel chamber and the cameras must also be included.

The reference light source can be provided by mounting an LED inside the chamber in the camera field of view. The emitted light intensity is controlled by the current level and duration.

Interpretation of Results

Because low energy ignition sources produce faint light, detection is best performed by examination of the 35 mm negatives using a light box and magnifying glass. If light sources are found on the negatives, they should be examined to determine if they are associated with the component being tested. This is done by comparing the test photograph with the background photograph taken earlier. Often imperfections in the negative will produce apparent sources that are not associated with the test item. If the apparent source does coincide with a critical portion of the test item, then the part should be inspected for physical evidence of sparking.

Hot Spots

The probability of ignition from hot spots can be evaluated by taking a photographic densitometer reading of the 35 mm negative test frame images. Data from tests using the Standard Hot Spot Ignition Source, which uses a 1.6 cm² stainless steel foil (both sides exposed to the test chamber), showed that for ASA 1600 black and white film a reading of 0.7 or less indicated that the hot spot would not cause an ignition. A reading of 1.2 or greater indicated that an ignition could occur. For infrared film, a reading of 0.6 or less indicated that a hot spot would not cause an ignition. A reading of 2.1 or greater indicated that an ignition could occur.

Voltage Sparks

Evaluation of voltage spark source ignition probability is performed by measuring the image area recorded on film and comparing it with experimental data obtained from the Standard Voltage Spark Ignition Source which uses a 2 mm spark gap. Typical data is presented in graph form in Figure 5.

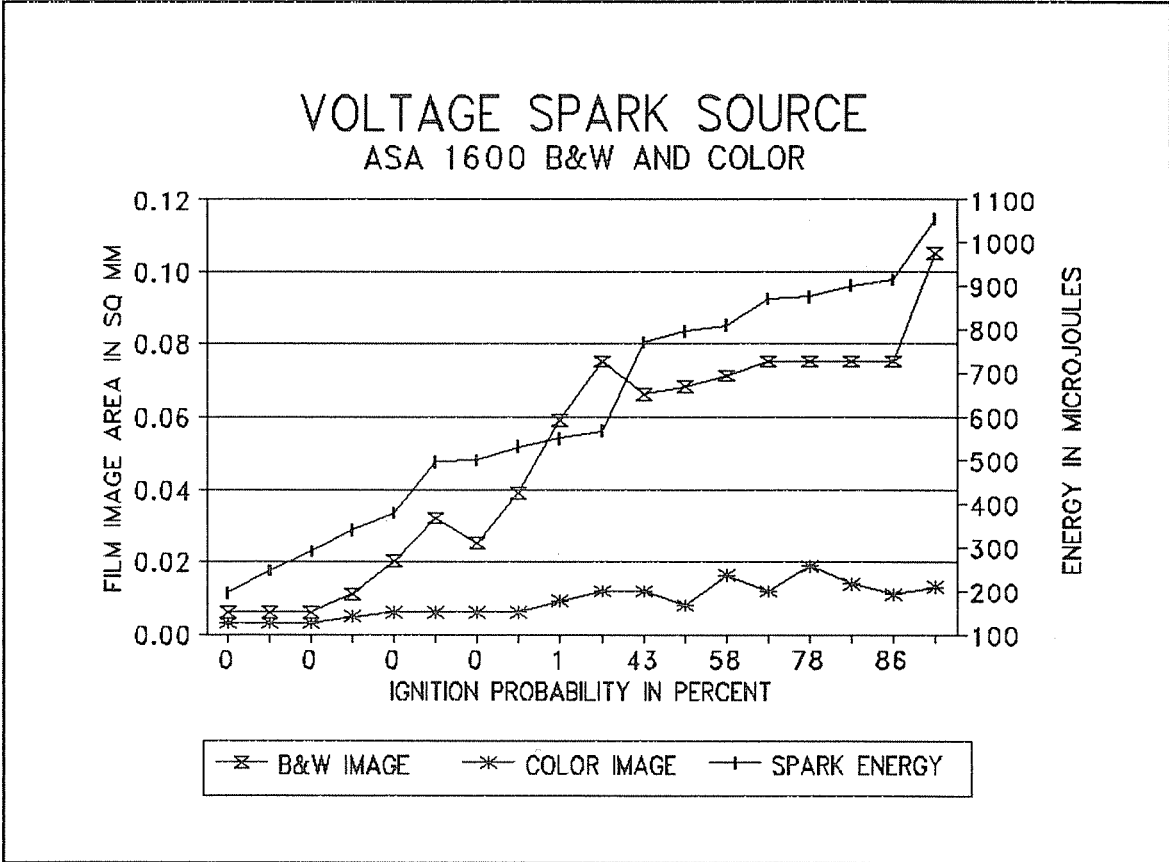

Note: Ignition probability of zero percent on the graph represents an actual probability of less than 0.01%.

Figure 5 - Film Image Areas vs. Probability of Ignition for Voltage Sparks

APPENDIX E

LT-94-1031

AIRCRAFT FUEL SYSTEM LIGHTNING
PROTECTION DESIGN AND
QUALIFICATION TEST PROCEDURES
DEVELOPMENT

Combustible Vapor Ignition Detection Technique

Prepared by:



K. E. Crouch

Approved by:



J. A. Plumer

For

Federal Aviation Administration
Technical Center
Atlantic City Int'l Airport, NJ 08405

Contract No. DTFA03-92-C-00003

LTI Project No. 1074

February 1994

Lightning Technologies, Inc.
10 Downing Parkway
Pittsfield, MA 01201
USA

1. Report No.		2. Government Accession No.		3. Recipient's Catalog No.	
4. Title and Subtitle Aircraft Fuel System Lightning Protection Design and Qualification Test Procedures Development: Combustible Vapor Ignition Detection Techniques				5. Report Date February 1994 Revised 2 May 1994	
				6. Performing Organization Code	
7. Author(s) Keith E. Crouch				8. Performing Organization Report No. LT-94-1031 Revision A	
9. Performing Organization Name and Address Lightning Technologies, Inc. 10 Downing Parkway Pittsfield, MA 01201				10. Work Unit No. (TRAIS) DTFA03-92-C-00003	
				11. Contract or Grant No.	
12. Sponsoring Agency Name and Address DOT/FAA FAA Technical Center Atlantic City Int'l Airport, NJ 08405				13. Type of Report and Period Covered Interim Report	
				14. Sponsoring Agency Code	
15. Supplementary Notes					
16. Abstract The background, theory, and practice necessary to use the combustible vapor ignition detection technique is described along with suggested equipment and interpretation of results.					
17. Key Words Lightning Qualification Fuels Design Testing			18. Distribution Statement		
19. Security Classif. (of this report) Unclassified		20. Security Classif. (of this page) Unclassified		21. No. of Pages 10	22. Price

AIRCRAFT FUEL SYSTEM LIGHTNING
PROTECTION DESIGN AND
QUALIFICATION TEST PROCEDURES
DEVELOPMENT

Combustible Vapor Ignition Detection Technique

ISSUE AND APPROVAL RECORD

Rev	By	Date	Revision Approved by	Pages Revised or Added
A	K.E. Crouch	2 May 1994		Added text on low pressure venting, split Table 1 into two tables

TABLE OF CONTENTS

SECTION	PAGE NO.
Executive Summary	iii
Combustible Vapor Ignition Detection Technique	1
Loading the Test Volume	1
Filling	1
Exhausting	2
Venting	2
Testing Considerations	3
Application	3
Pass/Fail Criteria Selection	3
Equipment	4
Safety Considerations	6
Leak Rate Calculations	6
Exhaust Flammability	8
Test Sequence	9
Detection Technique Selection	9
Pass/Fail Criteria	9
Test Configuration	9
Testing	9
Interpretation of the Results	10

EXECUTIVE SUMMARY

The use of combustible gas mixtures containing hydrogen, argon, nitrogen, oxygen and other gases show great promise for detection of potential ignition sources and determining their margin with respect to propane/air. The mixtures are shown to burn with very low energy release levels resulting in quite low pressure buildup in the test volume.

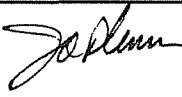
Proposed operating procedures, as well as cautions and interpretation information, is included to indicate the proper use of the technique. A section selection and interpretation of pass/fail criteria is also discussed.

COMBUSTIBLE VAPOR IGNITION DETECTION TECHNIQUE

The detection of ignition sources by the use of combustible vapors requires that there be flammable vapors in the volume surrounding the ignition source. The following paragraphs discuss the procedures, cautions, and equipment necessary to conduct tests using combustible vapors to detect ignition sources.

Loading the Test Volume

Filling

The vapors are normally introduced into the test volume using the flow/mixture/displacement method. The desired mixture is introduced into the volume of interest, mixed with the resident gases and the excess exhausted out of the volume. With free mixing in an unobstructed volume, the volume will be 98% filled with the entering mixture after four volumes have been introduced. In obstructed volumes containing areas of less than free mixing, additional flow volumes and forced mixing means must be added to attain adequate vapors around hidden sources. Fans in the chamber are often used to cause forced mixing. Another approach in confined spaces involves piping the incoming vapors to the area of confinement. For example, when tests are conducted on fuel vent couplings attached to lengths of vent pipe, the tubing carrying the mixture to the chamber can be routed into the chamber and to the end of the vent pipe. This insures that the mixture is introduced inside the vent pipe and coupling.

Although it is possible to purchase flowmeters with scales calibrated for various gases, it is probably more economical to purchase flowmeters calibrated for air and calculate the proper indication for the gas actually used. This can be accomplished using the gas specific gravity (air = 1) as follows:

$$Q_2 = Q_1 \times (1/S.G.)^{1/2}$$

Where:

Q_1 = Observed Flowmeter Reading

Q_2 = Actual Flow Corrected for Specific Gravity

1 = Specific Gravity of Air

S.G. = Specific Gravity of Gas used in Flowmeter Calibrated for Air

Back pressure in the tubing carrying the gases to the test chamber will also affect the flow rate and a similar calculation can be used to correct for pressure. However, most of the tests will be conducted in structures which cannot contain pressures of more than 1 or 2 psig. Since all of the gases flowing into the chamber will experience the same back pressure, they will all be subject to the same error and the relative volumes will still hold true.

The above considerations will suffice to insure that most flows are within the tolerances of the test procedure. However, when very precise flow control is required, a method of calibrating the delivered flow should be used. This can be done with mass flowmeter technology or with displacement calibrators.

Exhausting

During the filling process, and especially near the end of the fill, the vapors exiting the chamber will be flammable. The exhaust must be immediately mixed with sufficient quantities of room air to dilute the fuel used to levels below the flammability limit. Flammability limits of the fuels suggested for vapor testing are given in Table 1.

Table 1 Ignition Probabilities and Flammabilities	
Flammability Limits	
Maximum safe percentage (gas volume) of fuel in air to prevent ignition in the exhausted gasses.	
Propane	2.2%
Ethene (Ethylene)	3.1%
Ethyne (Acetylene)	2.5%
Hydrogen	4.0%

Venting

When the vapors in the test volume ignite, energy will be released as heat which will raise the temperature and pressure inside the test volume. The amount of temperature rise, and pressure rise, is dependent on the ratio of fuel to air in the mixture. With small amounts of fuel present (0.3 Stoichiometric or less) the burn will be slow and the energy will be released slowly. The resulting pressures may be almost insignificant. If tests are also made at full stoichiometric, then the need for venting will be much greater. If the reaction is contained, the internal pressures will exceed the structural limits of the container and a rupture will occur. To prevent an explosive rupture, a blow out vent must be installed in the container or test chamber. The size of the vent required depends on the volume contained and the proximity of the vent opening. The venting should always be placed as close to the center of the volume as possible. The vent opening should be at least 1 (unit)² of area for every 7 (units)³ of volume contained. If the venting cannot take place close to the center of the volume, then two vents in opposite directions should be used to eliminate pressure build up in the exhaust routes.

Testing Considerations

Application

Because venting is required during combustible vapor testing, the technique is better suited for coupon/panel tests than for full tank tests. In a test chamber, it is possible to mount the test panel or coupon so that the interior view is accessible for cameras behind a glass barrier. Using combinations of still cameras, motion picture cameras, and video cameras it is possible to view the flame front propagation and determine the source of the ignition. This procedure would be very difficult to implement in an actual fuel tank. Combustible vapor tests in a fuel tank with proper venting will determine pass/fail, but provide little information as to the source of the ignition.

Pass/Fail Criteria Selection

The pass/fail margin is determined in the Combustible Vapor Technique by adjusting the composition of the vapors in the mixture introduced into the test volume. As shown in Table 2, the different probabilities of ignition are given in terms of vapor mixture levels. To determine the margin of pass/fail, the tests can be conducted using vapor mixtures with ignition probabilities higher or lower than the requirement. If the design fails higher ignition probabilities or passes lower ignition probabilities than required, the difference is the margin of that design.

Measuring the pass/fail margin may be required by the procurement or regulatory agency or it may be desired by the design agency. In any case, the additional tests will require additional samples and test effort.

Table 2 Probability of Ignition as a Function of Gas Mixture and Spark Energy						
Fuel	% by Vol.	0.01%	0.1%	1.0%	10%	50%
		(microjoules)				
in Air						
Propane	4.8	435	480	555	645	785
Ethene						
Ethyne						
Hydrogen	28.0	20				
	15.0	50				
	12.0	100				
	9.0	200				
	7.0	500				
in Argon						
Hydrogen	28.0	15				
	18.0	20				
	10.0	50				
	7.0	15	18	25	35	55
	5.5	200				
	4.5	500				

Equipment

The following is a list of suggested equipment and supplies which can be used to supply the appropriate quantities of gas to the test chamber or test article. Other equipment with equivalent capabilities can also be used as desired by the laboratory.

Gases

Acetylene, Purified
Air, Dry
Argon, Prepurified
Ethylene, C.P.
Hydrogen, Prepurified
Nitrogen, Extra Dry
Oxygen, Extra Dry

Cylinder size

1A (except Acetylene - 1B)

Regulators

Model 8L, CGA as required for application

Matheson Gas Products
1650 Enterprise Pkwy
P.O. Box 358
Twinsburg, OH 44087
(216) 425-1791

Flowmeters

Series RM Rate-Master Flowmeters
Models RMB and RMA, ranges as required for specific applications

Dwyer Instruments, Inc.
P.O. Box 373
Michigan City, IN 46360
(210) 872-9141

Films

Kodak T-Max P3200 TMZ 135-36 (Developed at 1600 ASA)
Fuji Super HG 1600 CU 135-24
Polaroid 667 ASA 3000

Cameras

Ricoh 35 mm XR-10 SLR w/55 mm f/2.2 lens
Polaroid 600SE w/f/4.7 lens
Video Camcorder, CMR300, RCA

Test Chamber

The test chamber for component tests should be constructed of an opaque, electrically-insulating material such as G-10 fiberglass. The walls can be painted with black paint, inside and out, to darken the interior. A provision for mounting the cameras to the outside of one end will allow viewing during setup of the test. The dimensions of the chamber must be sufficient to accommodate anticipated fuel system components. A 2- x 2- x 4-foot chamber with a glass barrier (1/4-inch safety glass) in the center has been found to be adequate for most testing. A 14- x 14-inch blow-out opening has been found sufficient for venting the chamber.

A reference light source, used for orienting photographs in the darkened chamber, can be provided by mounting an LED inside the chamber in the camera field of view. The emitted light intensity is controlled by the current level and duration.

Hardware

PVC vinyl tubing, 1/4-, 1/2-, and 1-inch ID, hose barbs, gate valves, tubing squeeze-offs, and hose clamps as required are available from local vendors.

Safety Considerations

Working with hydrogen and other highly inflammable gases does present some risks. These gases are so highly ignitable that any significant leak must be considered to be a flame. Unfortunately, the flames are not readily visible. Hydrogen flames are actually invisible. This means that a leak in the handling system, regulator - flowmeter - tubing - etc., may not be detected until someone encounters the flame and is burned.

As stated previously, the exhaust from the filling process will be flammable, especially near the completion of a fill. Methods for dissipating the flammable exhaust are also presented.

The following paragraphs provide possible methods of handling these problems while maintaining a safe environment. The examples are specific to equipment and flow rates used at LTI, but can easily be adjusted to fit other situations.

Leak Rate Calculations

The volume of hydrogen stored between the regulator and the gang valve will primarily be contained in the 1/4-inch vinyl tubing connecting the parts of the system

together. Assuming that the total system volume can be represented by 10 feet of tubing (the actual length of tubing is approximately 6 feet), the volume is:

$$V = A \times l = 3.41 \cdot 10^{-3} \text{ ft.}^3$$

If the system is pressurized to 30 psig, and it loses 1 psig in 10 minutes, then the volume leaked into the atmosphere would be determined as follows:

The change in volume to reduce the pressure by 1 psi is:

$$P_1 V_1 = P_2 V_2$$

Where P_1 & V_1 are initial pressure and volume
 P_2 & V_2 are final pressure and volume

So
$$V_2 = (P_1/P_2)V_1$$

The volume lost to reduce the pressure is:

$$V_l = V_2 - V_1$$

This represents the volume of the gas at 29 psig, and it will expand as it goes to atmospheric pressure as follows:

$$V_l = (V_2 - V_1)P_2/P_3$$

Where P_3 is atmospheric pressure

In this case P_1 is roughly 45 psi, P_2 is 44 psi, and P_3 is 15 psi. Substituting into the above equations gives:

$$V_l = 1/15 V_1$$

Using the Volume determined above:

$$V_l = 227.33 \cdot 10^{-6} \text{ ft.}^3$$

or
$$V_l = 6.44 \cdot 10^{-3} \text{ l}$$

The total energy released by burning hydrogen is:

$$E = 10.80 \cdot 10^3 \text{ J/l}$$

The energy released by burning the volume leaked would be:

$$E = 69.50 \text{ J}$$

And the rate over 10 minutes (600 s) would be:

$$E = 0.116 \text{ W}$$

Since the system operating pressure would be closer to 5 psig than 30 psig, the actual leak would be about 1/6 of the above amount or:

$$E = 20 \cdot 10^{-3} \text{ W}$$

A 20 mW flame appears to be too small to actually exist and would not burn. The leak would be below the minimum flammability limit.

Approaching the problem from another way, the minimum hydrogen flame diameter is on the order of $7 \cdot 10^{-4}$ m and the minimum flame velocity is on the order of 2 m/s. This indicates that the volume of hydrogen necessary to support a flame is:

$$V_f = 770 \cdot 10^{-6} \text{ l/s}$$

If the volume lost in 10 minutes at 5 psig is:

$$V_l = 1.79 \cdot 10^{-6} \text{ l/s}$$

Then the above leak has a safety margin of 430:1, assuming the entire loss is in one spot. If the leak is the combination of several smaller leaks then the margin is even higher.

The loss of 1 psig in 10 minutes with 30 psig on the system appears to be very conservative. In fact the loss of 1 psig per minute would appear to be 40 times less than required to support a flame.

To verify the leak rate, the system should be pressurized with helium and the pressure drop monitored with time to determine what leaks may exist.

Exhaust Flammability

During filling of the test chamber, hydrogen, oxygen, and argon will be introduced into the chamber. If the chamber volume is about one cubic foot and is flow filled at a rate which will complete the process in about 15 minutes, the flow rate will be about 20 SCFH. The maximum hydrogen concentration in any mixture anticipated is 28% by volume. The lean limit for flammability of hydrogen is 4%. The oxygen flow rate would be 3 SCFH, the argon flow rate would be 11.4 SCFH and hydrogen would be 5.6 SCFH.

After mixing, the output vent from the chamber must be mixed with air at a flow rate of 120 SCFH to reduce the hydrogen content to a level of 4% or less. This exhaust could then be safely dumped out of the area with out fear of it being ignited.

Test Sequence

The following steps describe the process that should be followed to conduct lightning tests on a fuel system component using the CVIDT.

Detection Technique Selection

There are several routes which may lead to the selection of CVIDT as the technique for a specific test. If, for example, the test item is very complicated and it would be very likely that sparking could not be seen, even with aid of mirrors, then vapors would be a logical choice. Also, if the part were transparent or translucent, photographs would not be able to discern sparks against the high background light. The customer may also select vapor detection for reasons of his own.

Pass/Fail Criteria

The pass/fail criteria is usually determined by the customer. He will assess the total risk that he is willing to accept, since it is not possible to be totally risk free. The customer or any person setting the criteria will specify that he will be satisfied with 1.2 propane ("200 μ J"), twice as sensitive as propane ("100 μ J"), etc. Once this information is available, the test mixture can be selected and the system set up and calibrated.

Test Configuration

Depending on the complexity of the component(s) to be tested, the configuration of test can be selected. In most cases, the most information can be obtained by testing coupons or portions of the system in a test chamber, either attached to the front or suspended inside. In this mode, the article can be monitored with still and video/motion picture cameras to pinpoint problem areas that may occur.

If the test must be conducted on a full system, then an assessment of the probable ignition sources must be made, and venting holes must be cut or otherwise introduced to prevent rupture, using the rules given previously. It will not be possible to install cameras into the tank with the fuel as they would be ruined by the burn.

Testing

Test setup requirements are as those described for direct effects, structural damage tests (and indirect voltage tests for those cases where sparks in electrical equipment may result). For guidance, see the test procedures documents (i.e. SAE AE4L Report, Mil-Std-1757, AC 20-53).

If a test does not result in an ignition, then a secondary means of igniting the mixture must be introduced into the test volume to verify the mixture. Ideally, it would be preferable to introduce a low level voltage spark for this purpose. Practically, larger sparks can be used to ignite the mixture and with experience, the operator can judge the quality of the mix by the manner of burn. If the mixture is found to be poor, the test must be repeated.

Interpretation of the Results

Understanding the results of this type of test takes some analysis. For example if you conduct one test on a sample with a 1.2 stoichiometric propane/air mixture and get no ignition, you have shown that you are 90% confident that if a spark was present, it was less than 950 μJ 's. You are only 50% confident that it was less than 785 μJ 's and 1% confident that the spark was less than 555 μJ 's.

APPENDIX F

LT-94-1055

AIRCRAFT FUEL SYSTEM LIGHTNING
PROTECTION DESIGN AND
QUALIFICATION TEST PROCEDURES
DEVELOPMENT
Proposed Test Standard

Prepared by:

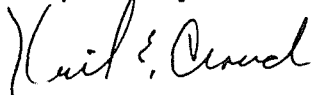

K.E. Crouch

Approved by:



J.A. Plumer

For

Federal Aviation Administration
Technical Center
Atlantic City Int'l Airport, NJ 08405

Contract No. DTFA03-92-C-00003

LTI Project No. 1074

April 1994

Lightning Technologies, Inc.
10 Downing Parkway
Pittsfield, MA 01201
USA

1. Report No.		2. Government Accession No.		3. Recipient's Catalog No.	
4. Title and Subtitle Aircraft Fuel System Lightning Protection Design and Qualification Test Procedures Development: Proposed Test Standard				5. Report Date April 1994	
				6. Performing Organization Code	
				8. Performing Organization Report No. LT-94-1055	
7. Author(s) Keith E. Crouch				10. Work Unit No. (TRAIS) DTFA03-92-C-00003	
9. Performing Organization Name and Address Lightning Technologies, Inc. 10 Downing Parkway Pittsfield, MA 01201				11. Contract or Grant No.	
				13. Type of Report and Period Covered Interim Report	
12. Sponsoring Agency Name and Address DOT/FAA FAA Technical Center Atlantic City Int'l Airport, NJ 08405				14. Sponsoring Agency Code	
15. Supplementary Notes					
16. Abstract The findings of the program are put in the format suggested by the Industrial Committees, EUROCAE WG-31 and SAE AE4L, to illustrate how they would be applied in test situations. The proposed standard recommends that combustible vapors, mixed to a specific sensitivity for the pass/fail criteria, be used to access the test results.					
17. Key Words Lightning Fuels Testing			18. Distribution Statement Qualification Design		
19. Security Classif. (of this report) Unclassified		20. Security Classif. (of this page) Unclassified		21. No. of Pages 7	22. Price

TABLE OF CONTENTS

SECTION	PAGE NO.
Executive Summary	iii
Introduction	1
Proposed Test Standard for Aircraft Fuel Systems	1
Background	1
Scope	2
Requirements	3
Containment Designs	3
Inerting and Foam Designs	3
Elimination of Ignition Sources	3
Pass/Fail Criteria Selection	6
Evaluating Multiple Tests	7

EXECUTIVE SUMMARY

Using the format of a revised industry standard created to replace the SAE AE4L Committee report *Lightning Test Waveforms and Techniques for Aerospace Vehicles and Hardware*, June 20, 1978, by EUOCAE WG-31 and SAE Committee AE4L, the findings of this program are used to propose techniques for conducting lightning tests on aircraft fuel systems. The proposal includes background information as well as procedures for conducting tests and selecting the pass/fail criteria. Methods for verifying the margin in a protection design are also discussed.

INTRODUCTION

This document is written using the format and paragraph numbering used in the EUROCAE and SAE AE4L Testing Standard Working Draft (Ref. 1). Only those paragraphs where changes are proposed are listed here.

PROPOSED TEST STANDARD FOR AIRCRAFT FUEL SYSTEMS

4.1.1.2 High Voltage Streamer Tests

Tests and theoretical calculations have shown glow discharges are not sufficient to ignite fuel/air mixtures. The standard voltage spark source uses a corona source to stabilize the gap break down, and that corona source (100 μ A) cannot ignite hydrogen/argon mixtures. The entire paragraph is to be deleted.

4.1.3 High Current Tests - Fuel System Components

BACKGROUND

Experience has shown that many of the catastrophic aircraft lightning incidents have involved the fuel system. Review of new aircraft designs gives no assurances that future experience will differ greatly from the past.

There are four basic approaches to protecting the aircraft from lightning related fuel vapor ignition hazards:

1. Containment - Design the structure to be capable of containing the resulting over pressure without rupture.
2. Inerting - Control the atmosphere in the fuel system to ensure that it cannot support combustion.
3. Foaming - Fill the fuel system volumes with a material which prevents the propagation of a flame front.
4. Elimination of Ignition Sources - Design the structure to ensure that no ignition sources are caused by lightning currents.

Ref. 1 EUROCAE WG-31 and SAE AE4L, Working Draft, "Aircraft Lightning Testing Standard, Testing for Design, Feasibility and Verification," Draft Version, 3 January 1994.

The first option utilizes the fuel system structure as a pressure vessel capable of withstanding the internal pressure resulting from an explosion. This approach is impractical for most systems and is mainly used for some external drop tanks.

Inerting, foaming and/or flame suppression systems are used on fighter-type aircraft, mainly to protect against gunfire hazards. These approaches are generally not applied to larger, longer range aircraft.

The procedures and techniques which follow, establish the test requirements for verifying the protection design of fuel systems for all approaches, but apply mostly for designs using the fourth and most common approach, elimination of ignition sources.

The accomplishment of a "spark-free" (ignition source free) design is quite challenging considering that tens of thousands of amperes of current are conducted by the structure during a lightning strike and a spark of 200 μ J can ignite a tank.

SCOPE

These procedures are intended to provide a means for showing that an aircraft fuel system design meets the requirements for protection against lightning initiated, fuel vapor ignition hazards for conventional designs as well as for those involving advanced composite structures or any other new techniques.

Ignition hazards include those due to direct effects (on fuel tank structures and plumbing) as well as indirect effects on wires or circuits in a fuel vapor cavity (such as fuel quantity probes). These procedures apply to fuel tanks and systems which are a part of the structure of an aircraft, as well as externally mounted tanks on wing tips, fuselage or other parts of the aircraft. The procedures apply to systems included in the initial design as well as modifications to existing fuel system components.

The procedures do not address the indirect induced effects (upset or damage) on either analog or digital electronic or electrical systems except as they relate to fuel ignition hazards.

The procedures are applicable to aerospace vehicles and parts or assemblies thereof. When these procedures are in conflict with the lightning test requirements found in the specifications, the requirements of this document govern, unless specifically deleted by the specification. (Note: The term "aerospace vehicles" includes fixed/variable wing aircraft, helicopters, missiles and spacecraft).

REQUIREMENTS

Aerospace vehicle fuel system protection designs verified using these procedures shall be shown to be protected against the hazards of lightning related ignitions for both direct and indirect effects. The lightning protection design shall be verified by similarity, test or analysis in accordance with the requirements listed below.

Containment Designs

Fuel systems and/or components designed to provide containment of the explosion shall be shown to be capable of withstanding an internal explosion. The system shall be filled with an explosive fuel/air mixture (1.2 stoichiometric propane air or equivalent) and ignited with an internal auxiliary spark source. Partial pressure or flow mixing techniques shall be used to introduce the fuel/air mixture. The system shall withstand the test with damage levels that do not exceed those called out in the system specification.

Inerting and Foam Designs

Fuel systems and/or components designed to contain inerting, flame suppressants, or foams shall be shown to be capable of preventing combustion in the system. Testing shall consist of the introduction of an auxiliary ignition source into a system filled with a combustible mixture to verify that combustion will not occur and/or that combustion cannot be supported after being initiated.

Elimination of Ignition Sources

Fuel systems and/or components designed to be "spark-free" shall be shown to withstand the applicable lightning currents for the lightning zone of the aircraft in which they are located without introducing ignition sources in fuel vapor areas. Testing shall be the preferred method of verification. Engineering design tests on subelement and subassembly (coupon samples) structures shall be conducted during the early design phase of the program to evaluate materials, fasteners, joints, interfaces, access doors, fuel caps, vent pipes, couplers, etc. Qualification tests shall also be conducted on coupon size samples. Tests may also be conducted on full assemblies (up to and including the full tanks) to verify the system capability. Full system tests will require the injection of test currents at many locations to ensure that all potential ignition sources have been stressed. Since observations inside such systems are difficult, the problem source may be hard to identify. Coupon samples are preferred.

Tests conducted at all levels (design and verification) shall be evaluated to determine the margin of safety provided by the design. Each test must consider potential ignition by voltage sparks, hot spots, and thermal sparks. These sources are defined as follows:

Voltage Sparks - An electrical breakdown of the fuel/air mixture between two separated conductors.

Hot Spots - A surface in contact with fuel/air mixtures which is heated by the conduction of lightning currents to a temperature which will ignite the mixtures.

Thermal sparks - Burning particles emitted by rapid melting and vaporization of conductive materials in point contact.

The use of fuel tank sealant materials (installed to prevent fuel leaks) to suppress and/or cover sparking in the fuel system shall be discouraged and be restricted to providing safety margin only.

4.1.3.1 Objective

Tests are conducted to determine the probability of ignition due to skin or component puncture, hot spot formation, or sparking in a region containing fuel vapors. The ignition hazard may be caused by lightning strikes attaching to the skin of the fuel system or being conducted through the area due to entry and exit points near or remote to the component.

4.1.3.2 Test Set-up

The test setup requirements are basically the same as those described in paragraph 4.1.2 for structural damage tests.

The combustible vapor ignition detection technique (CVIDT), with the ignition sensitivity adjusted to the pass/fail criteria specified, shall be used to detect all ignition sources.

The CVIDT uses still and motion picture (video) cameras to view the test item which aids in identifying the location of potential ignition sources. The test item is immersed in a mixture with the required sensitivity, and cameras are mounted behind a glass barrier. Further information on the CVIDT with application and calibration information are given in Appendix C of Reference 1.

4.1.3.3 Waveforms

The same test current waveform(s) should be applied as are specified for structural damage tests in paragraph 4.1.2 for the appropriate zone(s) in which the test specimen is located.

4.1.3.4 Measurements and Data Recording

Test current measurements are to be taken and recorded as specified in paragraph 4.1.2 for structural damage testing. The minimum data to be collected/recorded would be as follows:

- Description and photographs of test set-up
- Photographs of test specimens before and after testing
- Descriptions of damage (close-up photographs may be useful)
- Test current waveform(s) and magnitudes
- Sensitivity of fuel mixture
- Environmental data - Temperature, air pressure, and humidity
- Date, test personnel, witnesses, and location
- Deviations from test plan

4.3.1.5 Test Procedure

The following procedures are generic for a typical test conducted in a laboratory environment. The actual steps required will depend on the particular test equipment and test item. Each laboratory will have steps unique to their operations which will be followed during their tests.

- a) Setup high current generator(s), discharge circuit, return conductors, test chamber, gas flow system, measurement and recording equipment.
- b) Insert dummy test object or connect shorting straps to the circuit so that approximate waveform and generator verifications can be made without damaging the test item.
- c) Inspect test area, safety interlocks, test generators and connections to insure safe operation.
- d) Clear test area as required, charge and initiate discharge of generator(s) into dummy test object or straps to verify test generator operation. Verify waveforms, magnitudes, and operation of measuring equipment.
- e) Remove dummy test object or shorting straps, adjust the electrodes or conducted entry leads for the actual tests as required.
- f) Take background photographs of test item in test chamber. Install blow-out panels on chamber. Fill with test gas mixture, allowing time to achieve proper concentration. Ignite with auxiliary spark gap at level prescribed.
- g) Replace blow-out panels and refill chamber. Open camera lenses, start video camera.

- h) Charge generator(s) and initiate discharge into test object.
- i) Ground the generator output or otherwise insure that the test item is safe to work on, close camera shutters, and stop video camera. Ignite mixture if it did not ignite during test.
- j) Record appropriate data and prepare for next test as required.

4.1.3.6 Data Interpretation

The still and video camera films should be viewed to determine if any light was emitted during the tests, even if the mixture did not ignite. The cause of any light noted should be determined. If thermal sparks are observed, then more tests will probably be needed. Even under the most ideal conditions, it is almost impossible to get thermal sparks of equal levels. Several identical samples must be tested to insure that the thermal sparks will not ignite during a subsequent test.

PASS/FAIL CRITERIA SELECTION

It is the responsibility of the manufacturer, in conjunction with the appropriate procuring or regulatory agency, to establish the pass/fail criteria for the fuel system. The selection requires that an analysis of risks be made, since it is not possible to design a risk-free system. The analysis will need to consider the aircraft strike rate, the probability of a strike to the area which would affect the component under test, and the probability of an explosive mixture being present in the void.

The voltage spark ignition energy levels of propane, JP-4, JP-5, and JP-8, in the most sensitive mixtures, are very nearly identical. This means that 1.2 stoichiometric propane/air represents the fuel system threat.

Propane/air will ignite 50% of the time at 550 μJ , 99% of the time at 900 μJ , and 1% of the time at 330 μJ . A 200 μJ voltage spark will result in an ignition of propane/air less than 1 time in 10,000 tries.

Suppose the strike incidence rate for an aircraft was 1 in 2000 hours, and the fuel system component was in an area where 10% of the strikes could attach to or be swept across. The rate for the component is 1 in 20,000 hours or $50 \cdot 10^{-6}$ per flight hour (pfh). During a normal flight, with the most volatile fuel expected during service (JP-4 for example), a flammable vapor may be present during 10% of the time. This lowers the incidence rate to 1 in 200,000 hours or $5 \cdot 10^{-6}$ pfh. The lightning strike test levels (200 kA) are predicated on an incidence rate of 0.2%, so the test represents an incidence rate of $10 \cdot 10^{-9}$ pfh.

If the pass/fail criteria for the system is set at 900 μJ , then the risk of a lightning strike resulting in an ignition would be $10 \cdot 10^{-9}$ pfh. If 550 μJ were selected, the rate would drop to $5 \cdot 10^{-9}$ pfh. At 330 μJ , the rate would be 10^{-10} pfh. However, if 200 μJ were selected, the rate would be 10^{-12} pfh.

The relative importance of these numbers depends on the total system risk analysis. In some parts of the system 10^{-5} is the best attainable and must be accepted. In other areas, attaining 10^{-15} may be required. This example is not intended to provide any guidance on what risk may be acceptable.

Once the pass/fail criteria has been selected, then a fuel mixture sensitivity can be selected. If it is desired to be 90% confident that a test passes the criteria, then the test gas must exhibit a 90% probability of ignition at that level.

Evaluating Multiple Tests

Qualification tests, and some design tests, are often conducted on a single test piece and may involve a single test. When the required test margins greatly exceed the environment, or the test response is very repeatable, a single test may be appropriate. In testing fuel systems, the detection vapor and the structure tend to respond statistically and the need for more than one test becomes much more important. Unfortunately, most qualification testing criteria does not address evaluating multiple test results. If one test fails, the item fails, if one out of ten fails, the item still fails. Under such a requirement, there is very little incentive to conduct more than one test.

The solution would be to establish a confidence level for the criteria, for which statistical calculations can be made. In terms of fuels testing, the criteria selected could be a 90% confidence that no sparks exceeding 550 μJ were present during the test.

To establish a method of verifying that such a criteria has been met, two assumptions must be made when conducting multiple tests. First, the ignition vs. energy characteristics of the detector mixture must be well established and known to at least a 99% confidence. This requires that a substantial number of tests have been conducted and used in computing the relationship between ignition probability and energy.

Second, and probably more difficult to verify, the repeated tests must be essentially identical. When thermal sparks are involved, which are present in a large portion of fuel system sparking, this assumption may not be easy to justify. However, without this assumption, no matter how flawed the assumption may be, no conclusions regarding multiple tests can be made.

If a mixture with known ignition probabilities is used in the chamber, and no ignition occurs during the first test, then the following conclusions can be drawn. Since no ignition occurred, it can be concluded with 90% confidence that the energy level

representing 90% ignitions was not exceeded. Similarly, there would be a 50% confidence that the 50% ignition energy level was not exceeded and only a 1% confidence that the 1% ignition energy level was not exceeded.

Suppose that the pass/fail criteria for the system is that there be a 90% confidence that no sparks exceeding 550 μJ are created by the test. If the mixture used during the test has a 50% probability of ignition at the 550 μJ level, the criteria is not met by a single, non-ignition test result. There are two possibilities. Retest with another mixture that has a 90% or greater probability of ignition at 550 μJ or retest several times with the same mixture.

Retesting with the same mixture will probably be easier than developing a new mixture since new formulations will require extensive testing to verify the ignition energy level probabilities. Table 1 gives some examples of how additional tests will increase the confidence that the tests are verifying that the resultant spark in the system does not exceed a specified level.

In the first example, the mixture used had a 90% probability of ignition at the pass/fail energy level specified. After the first test, there is a 10% chance (confidence) that the spark exceeded that energy level and a 90% chance (confidence) that the spark was less than the energy level. After a second test with no ignition, assuming that the second test resulted in a spark identical to that of the first test, there is an even greater confidence that the spark was lower than the 90% probability energy. Squaring the probability of the spark exceeding the level gives a 1% chance that the spark was greater than the level or a 99% chance that the spark is less than the energy selected. As the number of tests resulting in no ignitions increase, so does the confidence that the energy of the spark did not exceed the selected level.

The lower the probability of ignition of the selected energy level, as in example 2, the greater will be the number of non-ignition tests needed to achieve the same confidence that the sparking is below the selected energy level.

Example 3 shows the confidence levels associated with obtaining ignitions. It is interesting to note that after one test, what can be concluded about the energy of the spark is the same whether or not an ignition occurred.

Example 4 considers the problem where both ignitions and non-ignitions occur during the tests. With both occurring, it is possible to estimate the actual energy level of the spark. If one ignition occurs in two tries, it may be the 50% level. Two out of three indicates the 66% level. The confidence of those estimates can be calculated using statistical formulas appropriate for the distribution.

A mathematical formulation of above logic is no doubt possible, but is beyond the limited statistical experience of this author.

Table 1

Determining Confidence of Selected Ignition
Probability Levels as a Function of Repeated
Tests Conducted in Known Vapor Mixtures

Test No.	Ignition	Confidence that Spark was	
		Greater than level	Less than level
Example 1 - 90% Ignition Level Energy Selected			
1	n	10% ($P=.1$)	90%
2	n	1.0% ($P^2=.01$)	99%
3	n	0.1% ($P^3=.001$)	99.9%
Example 2 - 40% Level Selected			
1	n	60% ($P=.6$)	40%
2	n	36% ($P^2=.36$)	64%
3	n	21% ($P^3=.21$)	79%
Example 3 - 40% Level Selected			
1	y	60%	40% ($P=.4$)
2	y	84%	16% ($P^2=.16$)
3	y	94%	6% ($P^3=.06$)
Example 4 - Probable Spark Energy Level			
1	n		
2	y		50%
3	n		33%
4	n		25%
5	y		40%

